



Cam switches
CA Series



Overview

The range of cam switches **CA series** includes ratings from 12 to 630A and insulation voltages of 690V.

The CA series offers IP00 terminals protection degree (it's possible to increase the protection degree by mounting terminal covers, optionally available) and up to IP66 handle protection degree. Available with different mounting systems: rear and base mounting, both with screws.

Available diagrams for every application: ON-OFF switches, line switches, cam switches for motor control, ammeter and voltmeter switches, multi step switches.

Assembled with metal shaft and threaded stud bolts to ensure maximum operating reliability



■ Class V2 self-extinguishing thermoplastic housing

■ Positive opening double break contacts, silver alloy made.



Base mounting (12A-40A)

- All base mounting items (BL6 - BK6 handles) include a 175 mm (6.89") shaft.
- Terminals with self raising plate and captive screws for sizes 12 ÷ 20A and 25 ÷ 40A.
- Connection terminals with screws provided with cable clamp for switches up to 100A and with cable coupling for bigger sizes.

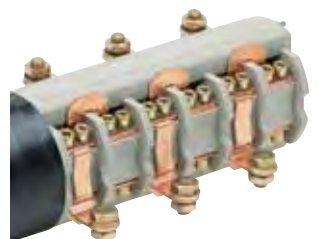

■ New compact size

The new release of the CA series has been redesigned to be more compact, while preserving the electrical performances.

Total length (rear mount) Number of elements	CA012/020		CA025/040	
	New release	Old release	New release	Old release
1	36,5mm (1,44 in)	38,0mm (1,50 in)	42,5mm (1,68 in)	49,5mm (1,94 in)
2	49,0mm (1,93 in)	51,0mm (2,01 in)	59,0mm (2,32 in)	65,5mm (2,58 in)
3	61,0mm (2,41 in)	63,0mm (2,49 in)	75,0mm (2,96 in)	81,5mm (3,22 in)
4	73,5mm (2,90 in)	75,5mm (2,97 in)	91,5mm (3,60 in)	98,0mm (3,86 in)
5	85,5mm (3,37 in)	87,5mm (3,45 in)	107,5mm (4,23 in)	114,0mm (4,49 in)
6	97,5mm (3,85 in)	100,0mm (3,93 in)	123,5mm (4,87 in)	130,5mm (5,13 in)

A new additional benefit for this new release of the CA series is the improved connection capability of the terminals, that allows to use wires with larger cross-sections and eases the use of ferrules.

Maximum cross-sections are now:

- CA012-020: 4 mm² solid and flex wire (AWG 12)
- CA025-040: 10 mm² solid and flex wire (AWG 8)



CA012-040

This new release of the CA series allows 2-screw fixing options with two layouts:

- 2 holes at 28mm (1.10") vertical distance
- 2 holes at 32mm (1.26") horizontal distance



■ Customized solutions

In our archive are available more than 10,000 diagrams to tailor every customers' needs.

(see page 99)

**Technical data
IEC 947-3
EN 60947-3**

			CA012
Rated insulation voltage	Ui	V	690
Rated operating voltage	Ue	V	690
Rated impulse withstand voltage	Uimp	kV	6
Rated thermal current for open switch	Ith	A	16
Rated thermal current for enclosed switch	Ithe	A	16
Rated operation frequency		Hz	50
Power dissipation for each pole		W	0,27
Rated operating current			
AC-21A Switching resistive loads, including moderate overloads	Ie	A	12
AC-22A Switching of mixed resistive and inductive loads, including moderate overloads	Ie	A	12
AC-20A Connecting and disconnecting under no load conditions			-
Rated operating power			
AC-23A Switching of motor loads or other highly inductive loads 3 phase - 3 pole	230V	Kw (A)	3 (9)
	400V	Kw (A)	4 (9)
	500V	Kw (A)	-
	690V	Kw (A)	-
AC-23A Switching of motor loads or other highly inductive loads 1 phase - 2 pole	110V	Kw (A)	0,75 (8,5)
	230V	Kw (A)	1,5 (8,5)
AC-3 Squirrel cage motors: starting, switching off motors during running 3 phase - 3 pole	230V	Kw (A)	2,2 (7)
	400V	Kw (A)	3,5 (7)
	500V	Kw (A)	-
	690V	Kw (A)	-
AC-3 Squirrel cage motors: starting, switching off motors during running 1 phase - 2 pole	110V	Kw (A)	0,37 (4)
	230V	Kw (A)	1,1 (6)
	400V	Kw (A)	-
AC-4 Squirrel cage motors: starting, plugging, inching	230V	Kw (A)	-
	400V	Kw (A)	-
AC-15 Control of a.c. elettromagnetic loads	230V	A	4
	400V	A	3
Rated breaking capability in category in AC-23A (cos φ=0,45)	230V	A	72
	400V	A	72
Short circuit protection			
Rated short time withstand current	Icw	A	150
Rated short-circuit make capacity	Icm	A	-
Rated conditional short-circuit current	-	kA	4
With fuses class gG	500V	A	16

**Technical data
UL/CSA**

Rated insulation voltage	Ui	UL/CSA V	600/ -
Rated operating voltage	Ue	UL/CSA V	600/ -
General Use Current	Ie	UL/CSA A	12
Short Circuit Rating@600Vac		Arms	5000
Fuse size (Class RK5, 600Vac, 200kA A.I.C.)		A	60
Rated operating power			
1 phase - 2 pole	120V	Hp (A)	0,5 (9,8)
	240V	Hp (A)	1,5 (10)
3 phase - 3 pole	200V	Hp (A)	1,5 (6,9)
	240V	Hp (A)	2 (6,8)
	480V	Hp (A)	3 (4,8)
	600V	Hp (A)	5 (6,1)

Mechanical characteristics

Mechanical life		Cycles x 10 ⁶	2	
		Cicles/hour	120	
Connections according to IEC 9471-1 and EN 60947-1				
Connecting capability	Connecting capability with flexible wires	Min-Max	mm ²	2x1,5-4
		Min-Max	AWG	16-10
	Connecting capability with solid wires	Min-Max	mm ²	2x1,5-6
Connection terminal screw dimensions		Type	M3,5	
Screw tightening torque		Nm	1,0	
Protection degree IEC 529 EN 60529				
Terminals		IP		
Ambient conditions				
Operating ambient temperature		°C		
Storage ambient temperature		°C		
Withstand to constant humid according to IEC 60068				
Withstand to cyclic humid according to IEC 60068				

CA016	CA020	CA025	CA032	CA040	CA050	CA063	CA100	CA200	CA400	CA630
690	690	690	690	690	690	690	690	690	690	690
690	690	690	690	690	690	690	690	690	690	690
6	6	6	6	6	6	6	6	6	6	6
20	25	32	32	40	50	75	115	200	400	630
20	25	32	32	40	50	75	100	160	-	-
50	50	50	50	50	50	50	50	50	50	50
0,5	0,4	1,0	1,0	1,3	1,6	2,5	4,7	7	15	30
16	20	25	32	40	50	75	115/110 ⁵	160 ⁵	-	-
16	16	20	25	32	40	63 ⁵	110	160	-	-
-	-	-	-	-	-	-	-	-	400	630
4 (14)	5,5 (17)	7,5 (24)	8,5 (27)	10 (32)	15 (48)	18,5 (58)	30 (95)	40 (125)	-	-
7,5 (14)	9 (16)	11 (20)	15 (27)	18,5 (30)	25 (45)	30 (54)	45 (85)	59 (106)	-	-
-	9 (13)	11 (15)	15 (22)	18,5 (27)	33 (48)	22 (32)	30 (40)	75 (108)	-	-
-	9 (9)	11 (11)	15 (16)	18,5 (19)	22 (23)	-	-	-	-	-
1,1 (12)	1,1 (5)	2,2 (25)	2,2 (25)	3 (34)	3,7 (42)	5,5 (63)	9 (102)	11 (125)	-	-
2,2 (14)	3 (17)	3,7(20)	3,7(20)	5,5 (30)	7,5 (40)	10 (32)	15 (82)	22 (120)	-	-
3,7 (12)	4 (13)	5,5 (17)	5,5 (17)	7,5 (24)	11 (35)	15 (47)	22 (70)	30 (95)	-	-
5,5 (10)	7,5 (14)	9,5 (16)	10 (17)	15 (27)	18 (33)	22 (40)	37 (67)	45 (82)	-	-
-	7,5 (11)	9,5 (12,5)	10 (14)	15 (22)	22 (32)	22 (32)	30 (40)	59 (85)	-	-
-	7,5 (8)	8,5 (10)	10 (10)	16 (16)	20 (20)	-	-	-	-	-
0,75 (9)	1,1 (13)	1,5 (17)	1,5 (17)	2,2 (25)	3,7 (42)	4 (45)	7,5 (85)	9 (102)	-	-
1,5 (8)	2,2 (12)	3 (17)	3 (17)	4,5 (25)	7,5 (40)	7,5 (40)	11 (60)	15 (82)	-	-
-	3,7 (12)	-	-	-	-	-	-	-	-	-
-	1,5 (4,5)	2,2 (7)	2,2 (7)	3 (10)	3,7 (12)	5,5 (17)	7,5 (85)	-	-	-
-	2,2 (2,6)	3 (5,5)	3 (5,5)	5,5 (10)	6 (11)	7,5 (14)	11 (20)	-	-	-
6	7	8	8	10	-	-	-	-	-	-
4	5	6	6	8	-	-	-	-	-	-
112	136	192	216	256	384	464	760	1000	-	-
112	128	160	216	240	360	432	680	848	-	-
240	240	400	400	500	600	800	1500	2000	-	-
-	1500	2000	2000	2000	2000	2500	3000	3000	-	-
4	5	10	10	10	15	15	15	15	-	-
20	20	35	35	50	50	63	125	200	-	-
600/-	600/300	600/600	600/600	600/600	600/600	600/600	600/600	600/-	600/- ⁴	600/- ⁴
600/-	600/300	600/600	600/600	600/600	600/600	600/600	600/600	600/-	600/- ⁴	600/- ⁴
16	20/16	25/25	35/25	40/32	60/40	85/63	125/100	240/-	400/- ^{3 14}	630/- ^{3 14}
5000	5000									
25 (30)	60									
1 (16)	1,5 (20)/ -	2/ -	2/ -	3/ 2,5	5/ -	7,5/ -	10/5	-	-	-
2 (12)	3 (17)/ 2,5 ²	3/ 6	5/ -	7,5/ 4,5	10/ -	10/ -	15/12	-	-	-
2 (7,8)	5 (16,7)/ -	5/ -	7,5/5	10/ -	15/ -	20/ -	20/-	-	-	-
3 (9,6)	7,5 (22)/ 5 (16) ²	7,5/ -	10/ -	15/ 9,5	20/ -	20/ -	25/24	-	-	-
7,5 (11)	10 (14)/ -	10/ -	15/ -	20/ 20	30/ -	30/ -	40/50	-	-	-
7,5 (9)	10 (11)/ -	10/15	15/ 17	20/ 25	30/32,5	40/50	50/65	-	-	-
2	2	1,5	1,5	1,5	1,5	1	0,3	0,1	-	-
120	120	120	120	120	120	120	120	120	-	-
2x1,5-4	2x1,5-4	2x2,5-10	2x2,5-10	2x2,5-10	2x2,5-6	6-16	10-25	50-70 ¹	Terminals designed for cable lugs or copper bars suitable for bolts	
16-10	16-10	16-8	16-8	16-8	14-8	10-6	10-3	1/0-2/0		
2x1,5-6	2x1,5-6	2x2,5-16	2x2,5-16	2x2,5-16	2x4-10	10-25	10-25	16-35		
M3,5	M3,5	M4	M4	M4	M5	2XM5	M8	M10	M12X20	M16x25
1,0	1,0	47	47	47	2,8	2,8	2,8	23	40	98
00										
-25 ÷ +55										
-30 ÷ +70										
2-78										
2-30										

Notes: 1 = Terminals for M10 bolts

2 = CSA at 300 V

3 = to use similar category AC20

4 = UR approval

5 = at 500 V

CA 12-40A

Standard plates and knobs



Rear mount with screw fixing



Base mount with screw fixing



PL1 ⁽¹⁾

Transparent plate 52x52mm (2.05x2.05"), black knob, IP40



PL2 ⁽¹⁾

Transparent plate 75x75mm (2.95x2.95"), black knob, IP40



RL6 ⁽²⁾

Yellow plate 67x67 mm (2.64"x2.64"), red padlockable knob (max 3 padlocks), IP66



BL6 ⁽²⁾

Yellow plate 67x67 mm (2.64"x2.64"), red padlockable knob (max 3 padlocks), IP66

Optional plates and knobs



Rear mount with screw fixing



Base mount with screw fixing



RT4 ⁽²⁾

Gray plate 48x48mm, black knob, IP66



RT6 ⁽²⁾

Grey plate 67x67 mm (2.64"x2.64"), black knob, IP66



RK6 ⁽²⁾

Grey plate 67x67 mm (2.64"x2.64"), black padlockable knob (max 3 padlocks), IP66



BK6 ⁽²⁾

Grey plate 67x67 mm (2.64"x2.64"), black padlockable knob (max 3 padlocks), IP66

Possible fixing options in rear mount depend on the combination of the plate with the rear mount cam-switch body

(1) suitable for 2-screw fixing with 2 holes at 28mm (1.10") vertical distance

(2) suitable for 2-screw fixing with 2 holes at 28mm (1.10") vertical distance and 2 holes at 32mm (1.26") horizontal distance

(3) suitable for both 2-screw fixing (with 2 holes at 28mm (1.10") vertical distance and 2 holes at 32mm (1.26") horizontal distance) and 4-screw fixing (with 4 holes at 36x36mm (1.42"x1.42") and 48x48mm (1.89"x1.89") distance)

standard plates

optional plates

Rear mounting

2-screw fixing: 28mm (1.10") V.



PL1



PL2

■ ON-OFF switch 1 pole

 0001	Circuit diagram	Rated nom. current	Part no.	Pack	Part no.	Pack
		12A	CA0120001PL1	1	CA0120001PL2	R
16A			CA0160001PL2	R		
20A			CA0200001PL2	R		
25A			CA0250001PL2	1		
32A						
40A						

■ ON-OFF switch 2 pole

 0002	Circuit diagram	Rated nom. current	Part no.	Pack	Part no.	Pack
		12A	CA0120002PL1	1	CA0120002PL2	R
16A		R	CA0160002PL2	1		
20A		R	CA0200002PL2	1		
25A			CA0250002PL2	1		
32A			CA0320002PL2	1		
40A			CA0400002PL2	R		

■ ON-OFF switch 3 pole

 0003	Circuit diagram	Rated nom. current	Part no.	Pack	Part no.	Pack
		12A	CA0120003PL1	1	CA0120003PL2	R
16A		R	CA0160003PL2	1		
20A		R	CA0200003PL2	1		
25A		R	CA0250003PL2	1		
32A			CA0320003PL2	1		
40A			CA0400003PL2	1		

■ ON-OFF switch 4 pole

 0004	Circuit diagram	Rated nom. current	Part no.	Pack	Part no.	Pack
		12A	CA0120004PL1	1	CA0120004PL2	R
16A		R	CA0160004PL2	1		
20A			CA0200004PL2	1		
25A			CA0250004PL2	1		
32A			CA0320004PL2	1		
40A			CA0400004PL2	1		

 standard article

R = on Request

Rear mounting

2-screw fixing: 28mm (1.10") V.



PL1



PL2

Change-over switch 1 pole

 0005	Circuit diagram	Rated nom. current	Part no.	Pack	Part no.	Pack
	 R/L1	12A	CA0120005PL1	1	CA0120005PL2	R
16A				CA0160005PL2	1	
20A				CA0200005PL2	R	
25A				CA0250005PL2	R	
32A						
40A						

Change-over switch 2 pole

 0006	Circuit diagram	Rated nom. current	Part no.	Pack	Part no.	Pack
	 R/L1 S/L2	12A	CA0120006PL1	1	CA0120006PL2	R
16A		CA0160006PL1	R	CA0160006PL2	1	
20A				CA0200006PL2	1	
25A				CA0250006PL2	1	
32A				CA0320006PL2	1	
40A				CA0400006PL2	1	

Change-over switch 3 pole

 0007	Circuit diagram	Rated nom. current	Part no.	Pack	Part no.	Pack
	 R/L1 S/L2 T/L3	12A	CA0120007PL1	1	CA0120007PL2	R
16A		CA0160007PL1	R	CA0160007PL2	1	
20A				CA0200007PL2	1	
25A				CA0250007PL2	1	
32A				CA0320007PL2	1	
40A				CA0400007PL2	1	

Change-over switch 4 pole

 0039	Circuit diagram	Rated nom. current	Part no.	Pack	Part no.	Pack
	 R/L1 S/L2 T/L3 N/O	12A	CA0120039PL1	1	CA0120039PL2	R
16A		CA0160039PL1	R	CA0160039PL2	1	
20A				CA0200039PL2	1	
25A				CA0250039PL2	1	
32A				CA0320039PL2	1	
40A				CA0400039PL2	1	

standard article

R = on Request

Rear mounting

2-screw fixing: 28mm (1.10") V.



PL1



PL2

■ **Reversing switch 3 pole**

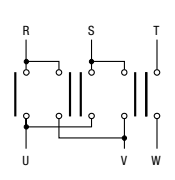
 0008	Circuit diagram	Rated nom. current	Part no.	Pack	Part no.	Pack
		12A	CA0120008PL1	1	CA0120008PL2	R
		16A	CA0160008PL1	R	CA0160008PL2	1
		20A			CA0200008PL2	1
		25A			CA0250008PL2	1
		32A			CA0320008PL2	1
		40A			CA0400008PL2	1

■ **Reversing switch 3 pole with spring return to "OFF"**

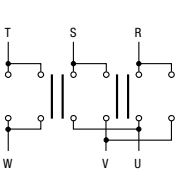
 0036	Circuit diagram	Rated nom. current	Part no.	Pack	Part no.	Pack
		12A	CA0120036PL1	1	CA0120036PL2	R
		16A			CA0160036PL2	1
		20A			CA0200036PL2	R
		25A				
		32A				
40A						

■ **Changing switch Dahlander pole**

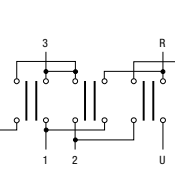
 0009	Circuit diagram	Rated nom. current	Part no.	Pack	Part no.	Pack
		12A	CA0120009PL1	1	CA0120009PL2	R
		16A	CA0160009PL1	R	CA0160009PL2	1
		20A			CA0200009PL2	1
		25A			CA0250009PL2	1
		32A			CA0320009PL2	1
		40A			CA0400009PL2	1

■ **STAR-DELTA Starter**

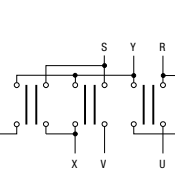
 0010	Circuit diagram	Rated nom. current	Part no.	Pack	Part no.	Pack
		12A	CA0120010PL1	1	CA0120010PL2	R
		16A	CA0160010PL1	R	CA0160010PL2	1
		20A			CA0200010PL2	1
		25A			CA0250010PL2	1
		32A			CA0320010PL2	1
40A				CA0400010PL2	1	

 standard article

R = on Request

Rear mounting

2-screw fixing: 28mm (1.10") V.



PL1



PL2

Reversing switch pole changing

 0011	Circuit diagram	Rated nom. current	Part no.	Pack	Part no.	Pack
		12A	CA0120011PL1	1	CA0120011PL2	R
16A	CA0160011PL1	R	CA0160011PL2	1		
20A			CA0200011PL2	1		
25A			CA0250011PL2	R		
32A						
40A						

Switch single phase motor + aux phase

 0031	Circuit diagram	Rated nom. current	Part no.	Pack	Part no.	Pack
		12A	CA0120031PL1	1	CA0120031PL2	R
16A			CA0160031PL2	1		
20A			CA0200031PL2	1		
25A			CA0250031PL2	1		
32A						
40A						

Reversing switch single-phase motor + centrif.

 0034	Circuit diagram	Rated nom. current	Part no.	Pack	Part no.	Pack
		12A	CA0120034PL1	1	CA0120034PL2	R
16A	CA0160034PL1	R	CA0160034PL2	1		
20A			CA0200034PL2	R		
25A			CA0250034PL2	R		
32A						
40A						

Voltmeter switch 3 concatenated voltages

 0016	Circuit diagram	Rated nom. current	Part no.	Pack	Part no.	Pack
		12A	CA0120016PL1	1	CA0120016PL2	R
16A			CA0160016PL2	R		
20A						
25A						
32A						
40A						

standard article

R = on Request

Rear mounting

2-screw fixing: 28mm (1.10") V.



PL1



PL2

■ Voltmeter switch 3 concatenated voltages and 3 phase voltages

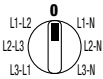
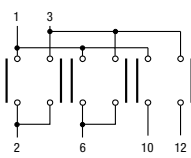
 0018	Circuit diagram	Rated nom. current	Part no.	Pack	Part no.	Pack
		12A	CA0120018PL1	1	CA0120018PL2	R
16A				CA0160018PL2	R	
20A						
25A						
32A						
40A						

■ Ammeter switch 1 pole 3 current transformers

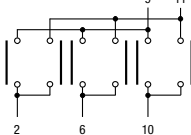
 0022	Circuit diagram	Rated nom. current	Part no.	Pack	Part no.	Pack
		12A	CA0120022PL1	1	CA0120022PL2	R
16A				CA0160022PL2	R	
20A						
25A						
32A						
40A						

■ Multi step switch with off 1 pole 3 steps

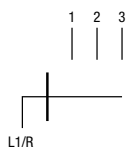
 MZ13	Circuit diagram	Rated nom. current	Part no.	Pack	Part no.	Pack
		12A	CS012MZ13PL1	1	CS012MZ13PL2	R
16A		CS016MZ13PL1	R	CS016MZ13PL2	R	
20A				CS020MZ13PL2	R	
25A						
32A						
40A						

■ Multi step switch with off 1 pole 4 steps

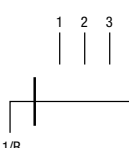
 MZ14	Circuit diagram	Rated nom. current	Part no.	Pack	Part no.	Pack
		12A	CS012MZ14PL1	1	CS012MZ14PL2	R
16A		CS016MZ14PL1	R	CS016MZ14PL2	R	
20A						
25A						
32A						
40A						

 standard article

R = on Request

Rear mounting

2-screw fixing: 28mm (1.10") V.



PL1



PL2

Multi step switch with off 2 pole 3 steps

Circuit diagram	Rated nom. current	Part no.	Pack	Part no.	Pack
	<p>MZZ23</p>	12A	CS012MZZ23PL1	1	CS012MZZ23PL2
16A				CS016MZZ23PL2	R
20A					
25A					
32A					
40A					

Rear mounting

2-screw fixing: 28mm (1.10") V. / 32mm (1.26") H.



RL6



RK6

Base mounting*

2-screw fixing: 28mm (1.10") V. / 32mm (1.26") H.



BL6



BK6

ON-OFF switch 3 pole with padlockable handle

Circuit diagram	Rated nom. current	Part no.	Pack	Part no.	Pack	Part no.	Pack	Part no.	Pack
	<p>00G3</p>	12A	CA01200G3RL6	1	CA01200G3RK6	R	CA01200G3BL6	1	CA01200G3BK6
16A		CA01600G3RL6	1	CA01600G3RK6	R	CA01600G3BL6	1	CA01600G3BK6	R
20A		CA02000G3RL6	1	CA02000G3RK6	R	CA02000G3BL6	1	CA02000G3BK6	R
25A		CA02500G3RL6	1	CA02500G3RK6	R	CA02500G3BL6	1	CA02500G3BK6	R
32A		CA03200G3RL6	1	CA03200G3RK6	R	CA03200G3BL6	1	CA03200G3BK6	R
40A		CA04000G3RL6	1	CA04000G3RK6	R	CA04000G3BL6	1	CA04000G3BK6	R

* Base mounting switches are supplied with standard 175mm (6.89") shaft



■ ON-OFF switch 4 pole with padlockable handle

Circuit diagram	Rated nom. current	Part no.		Part no.		Part no.		Part no.	
		Part no.	Pack	Part no.	Pack	Part no.	Pack	Part no.	Pack
	12A	CA01200G4RL6	R	CA01200G4RK6	R	CA01200G4BL6	R	CA01200G4BK6	R
	16A	CA01600G4RL6	1	CA01600G4RK6	R	CA01600G4BL6	1	CA01600G4BK6	R
	20A	CA02000G4RL6	1	CA02000G4RK6	R	CA02000G4BL6	1	CA02000G4BK6	R
	25A	CA02500G4RL6	1	CA02500G4RK6	R	CA02500G4BL6	1	CA02500G4BK6	R
	32A	CA03200G4RL6	1	CA03200G4RK6	R	CA03200G4BL6	1	CA03200G4BK6	R
	40A	CA04000G4RL6	1	CA04000G4RK6	R	CA04000G4BL6	1	CA04000G4BK6	R

* Base mounting switches are supplied with standard 175mm (6.89") shaft



■ Handle R03

Circuit diagram

Rated nom. current	0002		0003		0008		0009		0011	
	Part no.	Pack	Part no.	Pack	Part no.	Pack	Part no.	Pack	Part no.	Pack
12A	CA0120002R03	R			CA0120008R03	R	CA0120009R03	R	CA0120011R03	R
16A	CA0160002R03	R	CA0160003R03	R	CA0160008R03	R	CA0160009R03	R	CA0160011R03	R
20A	CA0200002R03	R	CA0200003R03	R	CA0200008R03	R	CA0200009R03	R	CA0200011R03	R
25A	CA0250002R03	R	CA0250003R03	R						

standard article

R = on Request

Switches with electromagnet



Device with safety electromagnet. It allows the spring return of the switch to "OFF" position in case of supply failure.

	B	H
PL2	32	75x75
RT6	39	67x67
RL6	39	67x67

dimensions in mm

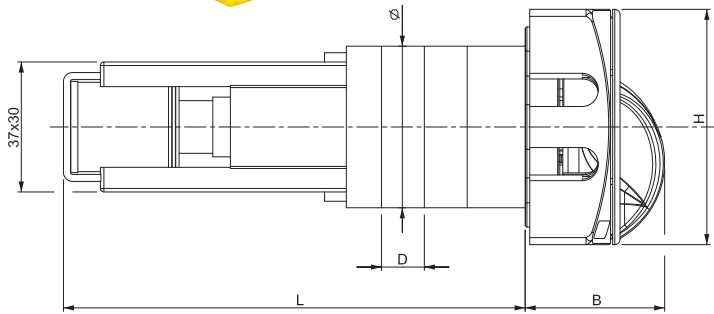

dimensions in mm

Stages no.	2	
CA 016 D = 12,2 ø = 40x46	L	126
CA 025 D = 16,2 ø = 58	L	140,5



RL6



PL2

Rear mounting

Circuit diagram

0035

Rated nom. current	Part no.	Pack	Part no.	Pack	Part no.	Pack	Part no.	Pack
16A	CA0160035E3RL6	1	CA0160035E3PL2	1	CA0160035E4PL2	R	CA0160035E5PL2	R
25A	CA0250035E3RL6	1						
* rat. n. voltage	110V		110V		220V		380V	



RT6

Rear mounting

Circuit diagram

0035







Rated nom. current	Part no.	Pack	Part no.	Pack	Part no.	Pack
16A	CA0160035E3RT6	R	CA0160035E4RT6	R	CA0160035E5RT6	R
25A	CA0250035E3RT6	R	CA0250035E4RT6	R	CA0250035E5RT6	R
* rat. n. voltage	110V		220V		380V	

* Rated nominal voltage



standard article

R = on Request

■ Plates

	Part no.	Description	Handle fixing option	Legend included		Pack
				Type	Degrees	
	FINPL1Q5	transparent plate 52x52mm (2.05x2.05"), black knob, IP40	Rear mounting with 2 screws	0 - 1 1 - 0 - 2	60°	5
	FINPL2Q5	transparent plate 75x75mm (2.95x2.95"), black knob, IP40	Rear mounting with 2 screws	0 - 1 1 - 0 - 2	60°	5
	FINRK6Q5 FINBK6Q5	grey plate 67x67mm (2.64x2.64"), black padlockable knob (max 3 padlocks), IP66	Rear mounting with 2 screws	0 - 1	90°	5 5
	FINRL6Q5 FINBL6Q5	yellow plate 67x67mm (2.64x2.64"), red padlockable knob (max 3 padlocks), IP66	Rear mounting with 2 screws	0 - 1	90°	5 5
	FINRT6Q5	grey plate 67x67mm (2.64x2.64"), black knob, IP66	Rear mounting with 2 screws	0 - 1 1 - 0 - 2	60°	5
	FINRT4Q5	grey plate 48x48mm (1.89x1.89"), black knob, IP66	Rear mounting with 2 screws	0 - 1 1 - 0 - 2	60°	5

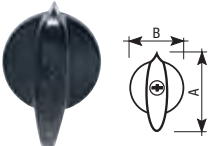
■ Knobs

	Part no.	Description	Pack
	M4G083N10	Black knob square section 5mm (0.20") 41x28 mm (1.61x1.10")	10
	M5G025N10	Black knob square section 5mm (0.20") 50x34 mm (1.97x1.34")	10
	M05G028N10	Black knob square section 5mm (0.20") 50x34 mm (1.97x1.34")	10
	M6G086N10	Black knob square section 7mm (0.28") 70x48 mm (2.76x1.89")	10
	MRNON10	black round knob Ø 38mm (1.50") square section 5mm (0.20")	10

 standard article

R = on Request

Protections

PVC protections against dust and dirt are available on request.



Terminal protection for diagrams 00G3,00G4



Part no.	Description	Pack
PROTLE6747	Terminals protection CA012 ÷ 020 2 stages	5
PROTLE6748	Terminals protection CA025 ÷ 040 2 stages	5

Optional shafts



Part no.	Description	Pack
PALBL300	Shaft L=300mm 05	5
PALBL500	Shaft L=500mm 05	5
PALBL065	Shaft L=65mm 05	R
PALBL075	Shaft L=75mm 05	R
PALBL095	Shaft L=95mm 05	R
PALBL115	Shaft L=115mm 05	R
PALBL135	Shaft L=135mm 05	R
PALBL155	Shaft L=155mm 05	R
PALBL175	Shaft L=175mm 05	5

■ Rear mounting - PL Handle

Measures in mm (in)

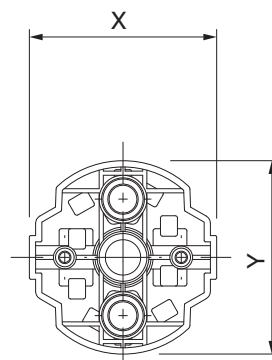
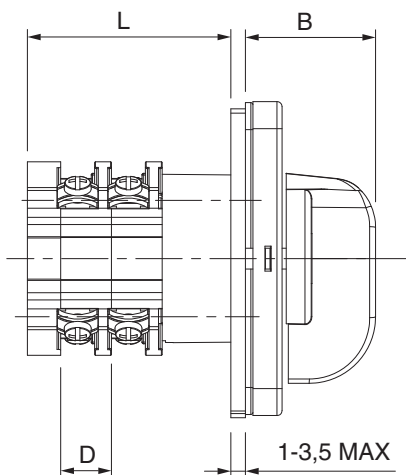

Series	X	Y	D		no. of stages					
					1	2	3	4	5	6
CA 012-016-020	45	∅ 46,5	12,2	L	36,7	49	61,1	73,3	85,5	97,7
	(1,77")	∅ (1,83")	(0,48")		(1,44")	(1,93")	(2,41")	(2,89")	(3,37")	(3,85")
CA 025-032-040	-	∅ 58,5	16,2	L	42,8	59	75	91,5	108	124
	-	∅ (2,30")	(0,64")		(1,69")	(2,32")	(2,95")	(3,60")	(4,25")	(4,88")

Handle	B
PL1	30 (1,18")
PL2	32 (1,26")

■ Base mounting - Handles BL6/BK6

(switching angle 90°, padlockable with max 3 padlocks)

Measures in mm (in)

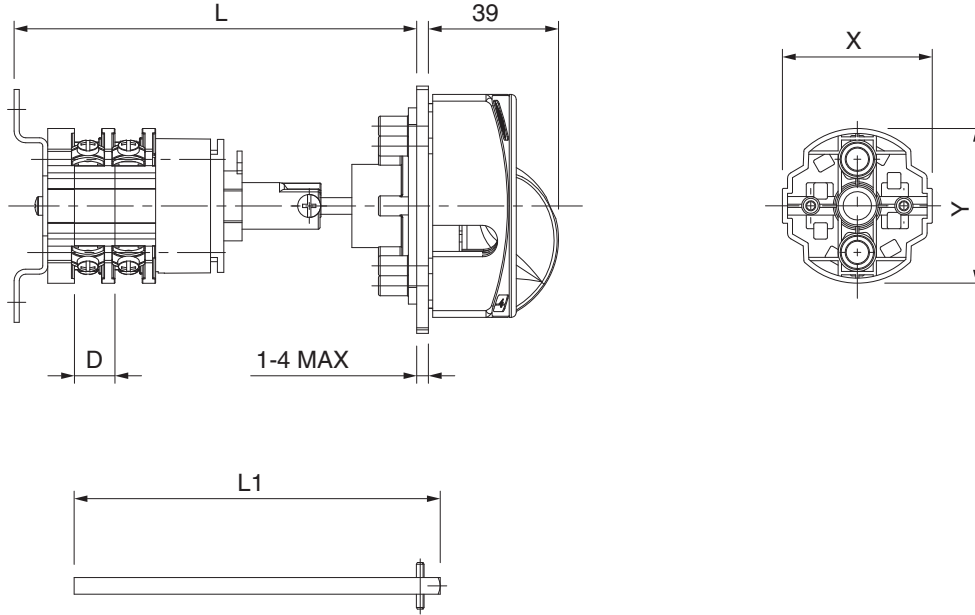

Overall length (min-max)** for different shaft lengths (L1):

Series	no. of stages			L1	2	
	X	Y	D		Lmin	Lmax
CA 012-016-020	45	∅ 46,5	12,2	175 (6.89")*	114 (4,49")	258 (10,16")
	(1.77")	∅ (1.83")	(0.48")	300 (11.81")	114 (4,49")	383 (15,08")
				500 (19.69")	114 (4,49")	583 (22,95")
CA 025-032-040	-	∅ 58,5	16,2	175 (6.89")*	117 (4,61")	261 (10,28")
	-	∅ (2.30")	(0.64")	300 (11.81")	117 (4,61")	386 (15,20")
				500 (19.69")	117 (4,61")	586 (23,07")

* Standard shaft, bundled

** Minimum length is obtainable by cutting the shaft

■ Drilling templates - Rear mounting

(RT - RL - RK) - Measures in mm (in)

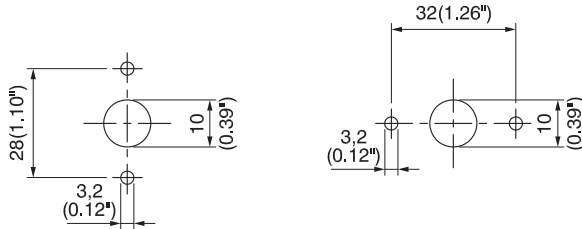

(PL)

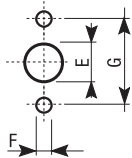

Dimensions

cod.	E		F		G	
PL1	10	0.39	3,2	0.15	28	1.10
PL2	10	0.39	3,2	0.15	28	1.10

■ Drilling templates - Base mounting

(BL6 - BK6) - Measures in mm (in)

Escutcheon plate mounting options:

1) 2 holes with vertical distance 28mm (1.10")

2) 2 holes with horizontal distance 32mm (1.26")

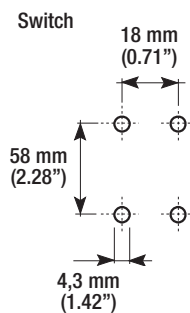
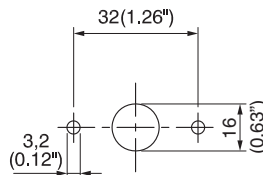
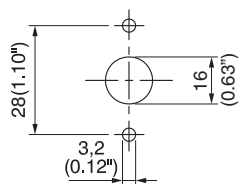

Switch mounting options:

1) 4 holes with distance 58x18mm (2.28x0.71")

CA 50-630A

Standard plates and knobs



Rear mount with screw fixing



Base mount with screw fixing



PL3 ⁽¹⁾

Transparent plate 105x105mm (4.13x4.13"), black knob, IP40



PL4 ⁽²⁾

Transparent plate 130x130mm (5.12x5.12"), black knob, IP40



3L3 ⁽¹⁾

Yellow plate 105x105mm (4.13x4.13"), red padlockable knob (max 3 padlocks), IP40



3L4 ⁽²⁾

Yellow plate 130x130mm (5.12x5.12"), red padlockable knob (max 3 padlocks), IP40



LE3 ⁽³⁾

Yellow plate 105x105mm (4.13x4.13"), red padlockable knob (max 3 padlocks), door interlock in "ON" position, IP54, terminals cover

LE4 ⁽⁴⁾

Yellow plate 130x130mm (5.12x5.12"), red padlockable knob (max 3 padlocks), door interlock in "ON" position, IP54, terminals cover

Optional plates and knobs



Rear mount with screw fixing



PL9 ⁽²⁾

Transparent plate 130x130mm (5.12x5.12"), black lever length 115 mm (4.53"), IP40



PL5 ⁽²⁾

Transparent plate 130x130mm (5.12x5.12"), black handwheel, IP40



3N3 ⁽¹⁾

Grey plate 105x105mm (4.13x4.13"), black padlockable knob (max 3 padlocks), IP40



Base mount with screw fixing



LN3 ⁽³⁾

Grey plate 105x105mm (4.13x4.13"), black padlockable knob (max 3 padlocks), door interlock in "ON" position, IP54, terminals cover

LN4 ⁽⁴⁾

Grey plate 130x130mm (5.12x5.12"), black padlockable knob (max 3 padlocks), door interlock in "ON" position, IP54, terminals cover

Possible fixing options in rear mount depend on the combination of the plate with the rear mount cam-switch body

(1) suitable for 2-screw fixing with 2 holes at 40mm (1.57") vertical distance

(2) suitable for 4-screw fixing with holes at 30 x 90mm (1.18" x 3.54") distance

(3) suitable for 4-screw fixing with □ 65 ÷ 85mm (□ 2,56" ÷ 3.35") holes layout

(4) suitable for 4-screw fixing with □ 94 ÷ 110mm (□ 3,70" ÷ 4.33") holes layout

standard plates optional plates

Rear mounting



PL3



PL4





PL9





PL5

■ ON-OFF switch 2 pole

 0002	Circuit diagram	Rated nom. current	Part no.	Pack	Part no.	Pack	Part no.	Pack	Part no.	Pack
			50A	CA0500002PL3	R					
		63A	CA0630002PL3	R						
		100A								
		200A								
		400A								
		630A								

■ ON-OFF switch 3 pole

 0003	Circuit diagram	Rated nom. current	Part no.	Pack	Part no.	Pack	Part no.	Pack	Part no.	Pack
			50A	CA0500003PL3	1					
		63A	CA0630003PL3	1						
		100A			CA1000003PL4	1	CA1000003PL9	R		
		200A			CA2000003PL4	1	CA2000003PL9	R		
		400A			CA4000003PL4	R	CA4000003PL9	R		
		630A							CA6300003PL5	R

■ ON-OFF switch 4 pole

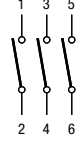
 0004	Circuit diagram	Rated nom. current	Part no.	Pack	Part no.	Pack	Part no.	Pack	Part no.	Pack
			50A	CA0500004PL3	1					
		63A	CA0630004PL3	1						
		100A			CA1000004PL4	1	CA1000004PL9	R		
		200A			CA2000004PL4	1	CA2000004PL9	R		
		400A								
		630A								

 standard article

R = on Request

Rear mounting



PL3



PL4



PL9



PL5

Change-over switch 2 pole

 0006	Circuit diagram	Rated nom. current	Part no.	Pack	Part no.	Pack	Part no.	Pack	Part no.	Pack
			50A	CA0500006PL3	1					
		63A	CA0630006PL3	1						
		100A			CA1000006PL4	1	CA1000006PL9	R		
		200A			CA2000006PL4	1	CA2000006PL9	R		
		400A					CA4000006PL9	R	CA4000006PL5	R
		630A					CA6300006PL9	R	CA6300006PL5	R

Change-over switch 3 pole

 0007	Circuit diagram	Rated nom. current	Part no.	Pack	Part no.	Pack	Part no.	Pack	Part no.	Pack
			50A	CA0500007PL3	1					
		63A	CA0630007PL3	1						
		100A			CA1000007PL4	1	CA1000007PL9	R		
		200A			CA2000007PL4	1	CA2000007PL9	R		
		400A					CA4000007PL9	R	CA4000007PL5	R
		630A							CA6300007PL5	R

Change-over switch 4 pole

 0039	Circuit diagram	Rated nom. current	Part no.	Pack	Part no.	Pack	Part no.	Pack	Part no.	Pack
			50A	CA0500039PL3	1					
		63A	CA0630039PL3	1						
		100A			CA1000039PL4	1	CA1000039PL9	R		
		200A			CA2000039PL4	1	CA2000039PL9	R		
		400A							CA4000039PL5	R
		630A							CA6300039PL5	R

standard article

R = on Request

Rear mounting



PL3



PL4



PL9



PL5

Reversing switch 3 pole

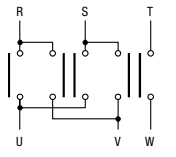
 0008	Circuit diagram	Rated nom. current	Part no.	Pack	Part no.	Pack	Part no.	Pack	Part no.	Pack
			50A	CA0500008PL3	1					
		63A	CA0630008PL3	1						
		100A			CA1000008PL4	1	CA1000008PL9	R		
		200A			CA2000008PL4	1	CA2000008PL9	R		
		400A					CA4000008PL9	R	CA4000008PL5	R
		630A							CA6300008PL5	R

Changing switch Dahlander pole

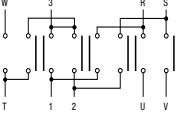
 0009	Circuit diagram	Rated nom. current	Part no.	Pack	Part no.	Pack	Part no.	Pack	Part no.	Pack
			50A	CA0500009PL3	1					
		63A	CA0630009PL3	1						
		100A								
		200A								
		400A								
		630A								

STAR-DELTA Starter

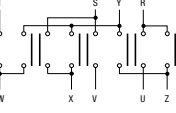
 0010	Circuit diagram	Rated nom. current	Part no.	Pack	Part no.	Pack	Part no.	Pack	Part no.	Pack
			50A	CA0500010PL3	1					
		63A	CA0630010PL3	1						
		100A			CA1000010PL4	1	CA1000010PL9	R		
		200A			CA2000010PL4	1	CA2000010PL9	R		
		400A								
		630A								

 standard article

R = on Request

Rear mounting



3L3



3N3



3L4

ON-OFF switch 3 pole with padlockable handle

 00G3		Rated nom. current	Part no.	Pack	Part no.	Pack	Part no.	Pack
		50A	CA05000G33L3	1	CA05000G33N3	R		
		63A	CA06300G33L3	1	CA06300G33N3	R		
		100A					CA10000G33L4	R
		200A					CA20000G33L4	R

ON-OFF switch 4 pole with padlockable handle

 00G4		Rated nom. current	Part no.	Pack	Part no.	Pack	Part no.	Pack
		50A	CA05000G43L3	1	CA05000G43N3	R		
		63A	CA06300G43L3	1				
		100A					CA10000G43L4	R
		200A					CA20000G43L4	R

Base mounting



LE3



LN3



LE4

ON-OFF switch 3 pole with padlockable handle

 00G3		Rated nom. current	Part no.	Pack	Part no.	Pack	Part no.	Pack
		50A	CA05000G3LE3	1	CA05000G3LN3	R		
		63A	CA06300G3LE3	1	CA06300G3LN3	R		
		100A					CA10000G3LE4	1
		200A					CA20000G3LE4	1



ON-OFF switch 4 pole with padlockable handle

 00G4		Rated nom. current	Part no.	Pack	Part no.	Pack	Part no.	Pack
		50A	CA05000G4LE3	1	CA05000G4LN3	R		
		63A	CA06300G4LE3	1	CA06300G4LN3	R		
		100A					CA10000G4LE4	1
		200A					CA20000G4LE4	1

standard article

R = on Request

Plates and knobs

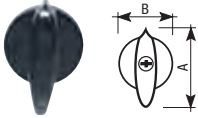
	Part no.	Description	Legend included		Pack
			Type	Degrees	
	FINPL3Q7	Rear mounting with screws, transparent plate 105x105mm (4.13x4.13"), black knob, IP40	0 - 1 1 - 0 - 2	60° 60°	5
	FINPL4Q10	Rear mounting with screws, transparent plate 105x105mm (5.12x5.12"), black knob, IP40	0 - 1 1 - 0 - 2	60° 60°	R
	FIN3L3Q7	Rear mounting with screws, yellow plate 105x105mm (4.13x4.13"), red padlockable knob (max 3 padlocks), IP40	0 - 1	90°	5
	M9G034N5	black knob square section 10mm (0.39") 105x75 (4.13x2.95")	-	-	5

Flexible PVC protections IP40

	Part no.	Description	Dimensions in mm (in)		Pack
			L	Ø	
	PROT2271003	CA050 up to 5 stages CA063 up to 4 stages	155 (6.10)	84 (3.31)	2

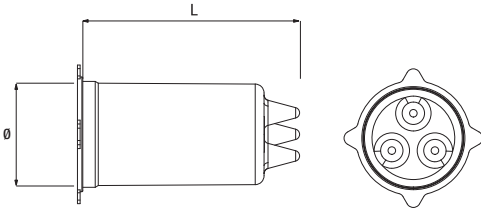

Terminals covers for diagrams 00G3,00G4

	Part no.	Description	Pack
	PROTLEG3229001	terminals cover CA050	2
	PROTLEG3229002	terminals cover CA063	2
	PROTLEG3942	terminals cover CA100-200	2

Shaft extensions with coupling

	Part no.	Description	Pack
	PALBL185	CA050-063, L.185mm (7.28"), □ 7mm (0.28")	10
	PALBL180Q10	CA100-063, L.185mm (7.28"), □ 10mm (0.39")	R

 standard article R = on Request

■ Base mounting - Handles LE/LN

(switching angle 90°, padlockable with max 3 padlocks)

Measures in mm (in)

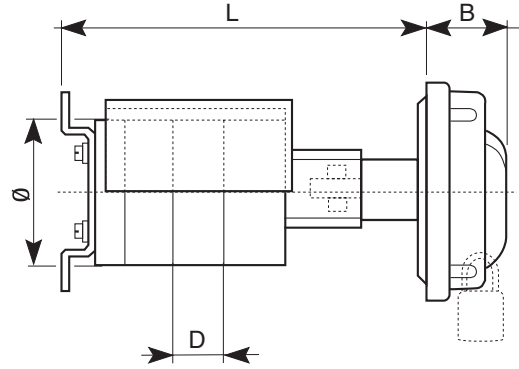

Stages no	2		Stages no	2	
CA 050			CA 100		
D = 18	L (mm)	135 - 139	D = 30	L (mm)	182 - 186
0.71	L (in)	5.31 - 5.47	1.18	L (in)	7.16 - 7.32
Ø = 74			Ø = 110		
2.91			4.33		
CA 063			CA 200		
D = 25	L (mm)	151 - 155	D = 39	L (mm)	200 - 204
0.98	L (in)	5.94 - 6.10	1.54	L (in)	7.87 - 8.03
Ø = 84			Ø = 110		
3.31			4.33		

	B	
	(mm)	(in)
LE3-LN3	44	1.73
LE4-LN4	62	2.44

■ Rear mounting - PL Handle

Measures in mm (in)

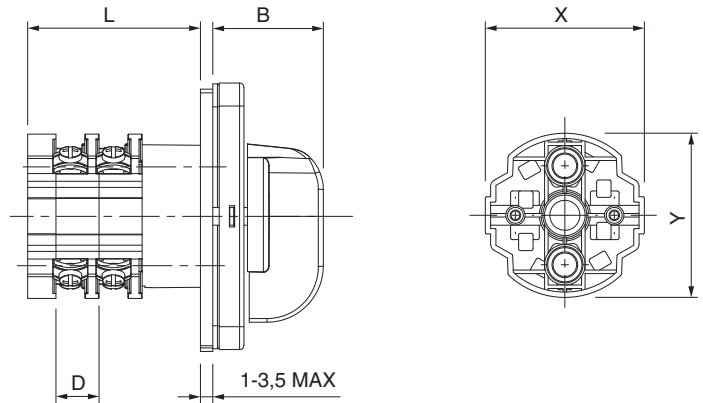

Series	X	Y	D		no. of stages					
					1	2	3	4	5	6
CA 050	-	Ø 74	18	L	52,5	70,5	88,5	106,5	125	142,5
	-	Ø (2,91")	(0,71")		(2,07")	(2,78")	(3,48")	(4,19")	(4,92")	(5,61")
CA 063	-	Ø 84	25	L	60,5	85,5	110,5	135,5	160,5	185,5
	-	Ø (3,31")	(0,98")		(2,38")	(3,37")	(4,35")	(5,33")	(6,32")	(7,30")
CA 100	-	Ø 110	30	L	80,8	110,8	140,8	170,8	200,8	230,8
	-	Ø (4,33")	(1,18")		(3,18")	(4,36")	(5,54")	(6,72")	(7,91")	(9,09")
CA 200	-	Ø 110	39	L	90	129	168	207	246	285
	-	Ø (4,33")	(1,54")		(3,54")	(5,08")	(6,61")	(8,15")	(9,69")	(11,22")

Handle	B
PL3	44 (1,73")
PL4	62 (2,44")
PL5	63 (2,48")
PL9	73 (2,87")
3N3-3L3	44 (1,73")
RL6-RK6	39 (1,54")