

# CLICKRAFT



75  
19 mm  
3/4"

72

60  
8-9 mm  
36-50 mm  
5/16"

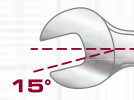

DOUBLE RATCHET  
**CLICKRAFT**

COMBINATION  
**CLICKRAFT**

XXL  
LARGO  
**CLICKRAFT**

LARGO 90  
**CLICKRAFT**

DOUBLE RING  
**CLICKRAFT**

REVERSIBLE  
**CLICKRAFT**

QUAD REVERSIBLE  
**CLICKRAFT**

FLEX  
**CLICKRAFT**

STUBBY FLEX  
**CLICKRAFT**

DOUBLE FLEX  
**CLICKRAFT**

ANGLE  
**CLICKRAFT**

180°



## Double ratchet combination wrench

flat, with additional ratcheting function in the open end

### Llave combinada doble carraca

plana, con mecanismo adicional efecto carraca en la boca abierta

### Chave boca-luneta com roquete duplo

direita, com mecanismo de roquete adicional na boca

## DOUBLE RATCHET CLICKRAFT

Art.	Ø mm	D mm	L mm	Ø
3401-08	8	17.7	140	60
3401-09	9	19.0	149	60
3401-10	10	21.1	159	72
3401-11	11	23.1	165	72
3401-12	12	24.5	172	72
3401-13	13	26.5	178	72
3401-14	14	27.9	190	72
3401-15	15	30.5	199	72
3401-16	16	32.4	208	72
3401-17	17	34.2	225	72
3401-18	18	35.3	236	72
3401-19	19	36.1	248	75
3401-20	20	42.3	270	72
3401-21	21	42.3	270	72
3401-22	22	42.3	291	72
3401-24	24	49.3	312	72

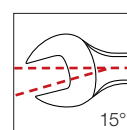

Video

[KRAFTWERKtools.com/video/double-ratchet](https://www.kraftwerktools.com/video/double-ratchet)

## Double ratchet combination wrench set

flat, with additional ratcheting function in the open end

### Juego de llaves combinadas doble carraca

planas, con mecanismo adicional efecto carraca en la boca abierta

### Jogo de chaves boca-luneta com roquete duplo

direitas, com mecanismo de roquete adicional na boca

4  
PCS

Art.	Ø mm
3401-50	10-13-17-19



3.003

**Double ratchet combination wrench set**

flat, with additional ratcheting function in the open end

**Juego de llaves combinadas doble carraca**

planas, con mecanismo adicional efecto carraca en la boca abierta

**Jogo de chaves boca-luneta com roquete duplo**

direitas, com mecanismo de roquete adicional na boca

**6**  
PCS

Art.	mm
<b>3401-51</b>	8-10-12-13-17-19



**Double ratchet combination wrench set**

flat, with additional ratcheting function in the open end

**Juego de llaves combinadas doble carraca**

planas, con mecanismo adicional efecto carraca en la boca abierta

**Jogo de chaves boca-luneta com roquete duplo**

direitas, com mecanismo de roquete adicional na boca

**12**  
PCS

Art.	mm
<b>3401-54</b>	8-9-10-11-12-13-14-15-16-17-18-19



↕ 325 x 185 x 56 mm

**Double ratchet combination wrench case**

flat, with additional ratcheting function in the open end  
(except 5.5-6-7 mm)

**Estuche de llaves combinadas doble carraca**

planas, con mecanismo adicional efecto carraca en la boca abierta  
(excepto 5.5-6-7 mm)

**Jogo de chaves boca-luneta com roquete duplo em mala**

direitas, com mecanismo de roquete adicional na boca  
(exceto 5.5-6-7 mm)

**15**  
PCS

\*Option / Opcionales / Opção

Art. 3691 ■ 1/4" x ● 10 mm

Art. 3692 ■ 3/8" x ● 13 mm

Art. 3693 ■ 1/2" x ● 19 mm

Art. 2694 ○ 1/4" x ● 10 mm



Art.	mm
<b>4900-40K</b>	5.5-6-7-8-9-10-11-12-13-14-15-16-17-18-19



↕ 421 x 200 x 68 mm

## Ratchet combination wrench

flat

*Llave combinada carraca**plana*

## Chave boca-luneta com roquete

direita

Art.	○ mm	D mm	L mm	○
<b>3405</b>	5.5	16.5	125	60
<b>3406</b>	6	17.0	125	60
<b>3407</b>	7	17.0	140	60
<b>3408</b>	8	17.0	140	60
<b>3409</b>	9	18.5	149	60
<b>3410</b>	10	20.5	160	72
<b>3411</b>	11	21.5	165	72
<b>3412</b>	12	23.0	170	72
<b>3413</b>	13	25.0	180	72
<b>3414</b>	14	28.0	190	72
<b>3415</b>	15	29.0	200	72
<b>3416</b>	16	30.0	210	72
<b>3417</b>	17	31.5	225	72
<b>3418</b>	18	33.0	235	72
<b>3419</b>	19	34.0	250	75
<b>3420</b>	20	41.0	290	72
<b>3421</b>	21	41.0	290	72
<b>3422</b>	22	41.5	290	72
<b>3424</b>	24	48.0	333	72
<b>3427M</b>	27	52.5	360	72
<b>3430M</b>	30	59.0	400	72
<b>3432M</b>	32	62.5	425	72
<b>3434M</b>	34	63.0	460	72
<b>N 3436M</b>	36	64.0	500	60
<b>N 3441M</b>	41	68.0	575	60
<b>N 3446M</b>	46	76.0	645	60
<b>N 3450M</b>	50	80.0	655	60

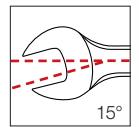



**Ratchet combination wrench set**

flat

**Juego de llaves combinadas carraca**

planas

**Jogo de chaves boca-luneta com roquete**

direitas

**4**  
PCS



Art.	mm
<b>3400-50</b>	10-13-17-19

**Ratchet combination wrench set**

flat

**Juego de llaves combinadas carraca**

planas

**Jogo de chaves boca-luneta com roquete**

direitas

**6**  
PCS



Art.	mm
<b>3427</b>	8-10-12-13-17-19

**Ratchet combination wrench case**

flat

**Juego de llaves combinadas carraca**

planas

**Jogo de chaves boca-luneta com roquete**

direitas

**12**  
PCS



↕ 325 x 185 x 56 mm

Art.	mm
<b>3400-54</b>	8-9-10-11-12-13-14-15-16-17-18-19



**COMPLETO**

**Ratchet combination wrench case**

flat, with socket- and bit-adapters

**Estuche de llaves combinadas carraca**

planas, con adaptadores para llaves de vaso y puntas

**Jogo de chaves boca-luneta com roquete em mala**

direitas, com adaptadores para chaves de caixa e bits

\* inklusiv / inclus / incluso



Art. 3691 1/4" x 10 mm

Art. 3692 3/8" x 13 mm

Art. 3693 1/2" x 19 mm



Art. 2694 1/4" x 10 mm



**19**  
PCS



421 x 200 x 68 mm

Art.	mm
<b>4900-17K</b>	5.5-6-7-8-9-10-11-12-13-14-15-16-17-18-19

**Ratchet combination wrench, inch**

flat

**Llave combinada carraca pulgada**

plana

**Chave boca-luneta com roquete, polegada**

direita

**inch**

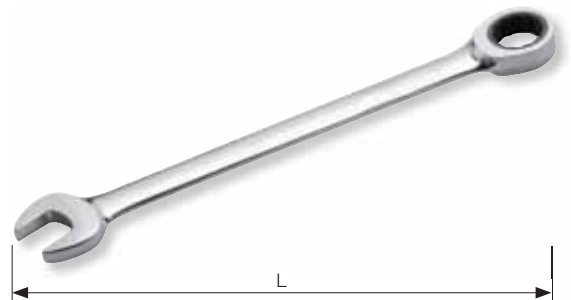

Art.	inch	D mm	L mm	Ø
<b>3431</b>	5/16"	17.0	140	60
<b>3432</b>	3/8"	20.5	160	72
<b>3433</b>	7/16"	21.2	165	72
<b>3434</b>	1/2"	25.5	180	72
<b>3435</b>	9/16"	28.0	190	72
<b>3436</b>	5/8"	30.0	210	72
<b>3437</b>	11/16"	31.5	225	72
<b>3438</b>	3/4"	34.0	250	75

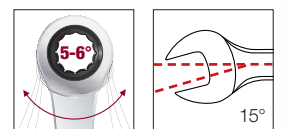

**Ratchet combination wrench set, inch**

flat

**Juego de llaves combinadas carraca en pulgadas**

planas

**Jogo de chaves boca-luneta com roquete, polegada**

direitas

**8**  
PCS

**inch**



Art.	inch
<b>3430</b>	5/16"-3/8"-7/16"-1/2"-9/16"-5/8"-11/16"-3/4"



3.007

**Ratchet combination wrench**

flat, mat chromed

**Llave combinada carraca**

plana, cromado mate

**Chave boca-luneta com roquete**

direita, cromada mate

Art.	Ø mm	D mm	L mm	Ø
1400-08	8	17.0	135	60
1400-09	9	21.0	160	60
1400-10	10	21.0	160	72
1400-11	11	23.0	165	72
1400-12	12	24.0	170	72
1400-13	13	25.5	180	72
1400-14	14	27.0	190	72
1400-15	15	29.0	200	72
1400-16	16	31.0	205	72
1400-17	17	33.0	225	72
1400-18	18	34.0	235	72
1400-19	19	35.0	245	72
1400-21	21	42.5	280	72
1400-22	22	43.0	280	72
1400-24	24	47.0	310	72

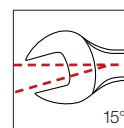
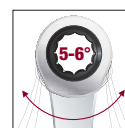

**Ratchet combination wrench set**

flat, mat chromed

**Juego de llaves combinadas carraca**

planas, cromado mate

**Jogo de chaves boca-luneta com roquete**

direitas, cromadas mate

Art.	PCS	Ø mm
1400-51	5	8-10-13-17-19
1400-53	13	8-9-10-11-12-13-14-15-16-17-18-19-22



## Ratchet combination wrench

flat, extra long

### Llave combinada carraca

plana, extra larga

### Chave boca-luneta com roquete

direita, extra longa

Art.	Ø mm	D mm	L mm	Ø
4402-08	8	17.5	150	60
4402-09	9	18.3	165	60
4402-10	10	21.3	180	72
4402-11	11	22.3	195	72
4402-12	12	24.0	207	72
4402-13	13	26.3	220	72
4402-14	14	28.2	235	72
4402-15	15	30.2	250	72
4402-16	16	32.0	260	72
4402-17	17	32.8	275	72
4402-18	18	33.6	290	72
4402-19	19	36.4	305	75
4402-20	20	41.2	318	72
4402-21	21	41.2	318	72
4402-22	22	41.2	330	72
4402-24	24	46.7	356	72

XXL

LARGO CLICKRAFT

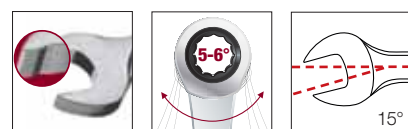
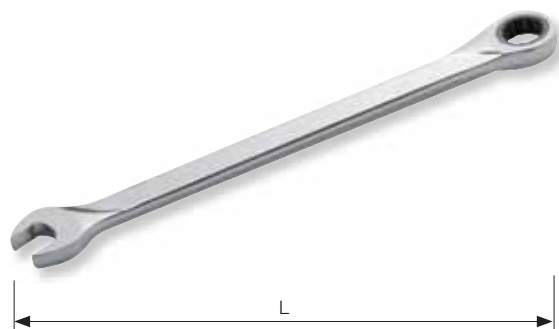

LARGO



quality tools



Motorsport





LARGO

+22%

STANDARD

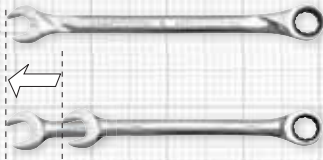

XXL

LARGO CLICKRAFT

**Ratchet combination wrench set**

flat, extra long

**Juego de llaves combinadas carraca**

planas, extra largas

**Jogo de chaves boca-luneta com roquete**

direitas, extra longas

\*Option / Opcionales / Opção



Art.	mm
4402-51	8-10-13-17-19

5  
PCS



**Ratchet combination wrench set**

flat, extra long

**Juego de llaves combinadas carraca**

planas, extra largas

**Jogo de chaves boca-luneta com roquete**

direitas, extra longas

\*Option / Opcionales / Opção



Art.	mm
4402-52	8-10-11-12-13-16-17-18-19

9  
PCS



**Ratchet combination wrench set**

flat, extra long

**Juego de llaves combinadas carraca**

planas, extra largas

**Jogo de chaves boca-luneta com roquete**

direitas, extra longas

\*Option / Opcionales / Opção



Art.	mm
4402-53	8-9-10-11-12-13-14-15-16-17-18-19

12  
PCS



## LARGO 90 combination ratchet wrench

500 % more contact and press area grace to the 90° crossbeam forge of the LARGO 90-wrench. Open and ring end sided working without tender spots in your hands since you work with the handle surface and not with the thin handle edge.

### Llave combinada con carraca LARGO 90

500 % de mayor contacto y area de presión gracias a su torsion a 90° de la nueva serio LARGO. La presión se realiza sobre una superficie plana en vez de sobre los bordes rectos de la llave permitiendo trabajar con una máxima ergonomía para la palma de la mano.

### Chave boca-luneta com roquete LARGO 90

500 % mais área de contacto e força graças aos 90° da nova chave LARGO 90. A pressão exercida na parte plana e não na parte lateral mais fina que permite um trabalhar em perfeita ergonomia com a mão.

Art.	Ø mm	D mm	L mm	Ø
4405-08	8	17.5	148	60
4405-09	9	18.3	163	60
4405-10	10	21.3	179	72
4405-11	11	22.3	193	72
4405-12	12	24.0	204	72
4405-13	13	26.3	219	72
4405-14	14	28.2	234	72
4405-15	15	30.2	248	72
4405-16	16	32.0	259	72
4405-17	17	32.8	274	72
4405-18	18	33.6	291	72
4405-19	19	36.4	305	75

## LARGO 90 combination ratchet wrench case

500 % more contact and press area grace to the 90° crossbeam forge of the wrench

### Estuche de llaves combinadas con carraca LARGO 90

500 % de mayor contacto y area de presión gracias a su torsion a 90° de la llave

### Jogo de chaves boca-luneta com roquete LARGO 90 em mala

500 % mais area de contacto e força graças aos 90° da nova chave

Art.	Ø mm
4900-28K	8-9-10-11-12-13-14-15-16-17-18-19

## LARGO 90 CLICKRAFT

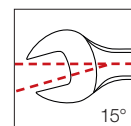
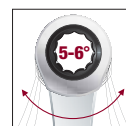
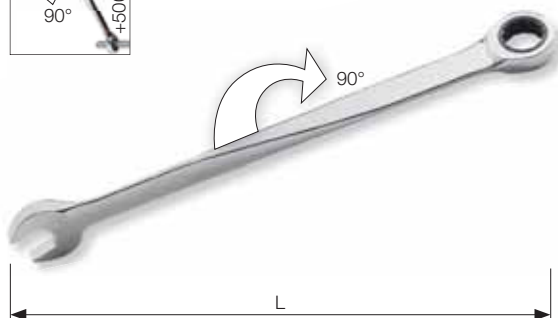
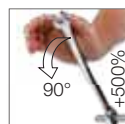

12  
PCS

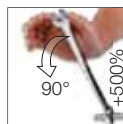

COMPLETO



421 x 200 x 68 mm



3.011

Double ring ratchet wrench

flat

*Llave poligonal doble con carraca*

*plana*

Chave luneta dupla com roquete

direita

Art.	mm	L mm	mm
<b>3441</b>	8 x 9	130	60
<b>3440</b>	8 x 10	128	60 x 72
<b>3442</b>	10 x 11	150	72
<b>3447</b>	10 x 13	160	72
<b>3443</b>	12 x 13	170	72
<b>3444</b>	14 x 15	187	72
<b>3445</b>	16 x 18	210	72
<b>3446</b>	17 x 19	230	72 x 75

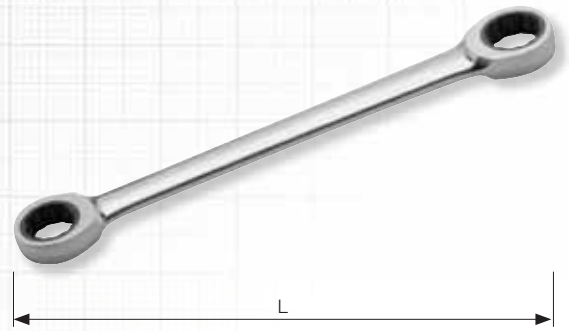

Double ring ratchet wrench set

flat

*Juego de llaves poligonales doble con carraca*

*planas*

Jogo de chaves luneta dupla com roquete

direitas

Art.	mm
<b>3455</b>	8 x 10 - 12 x 13 - 17 x 19

**3**  
PCS



250 x 110 x 35 mm

External TX double ring ratchet wrench

flat

*Llave de estrella doble con carraca TX exterior*

*plana*

Chave luneta com roquete TX exterior

direita

Art.	mm	L mm	mm
<b>3471</b>	E6 x E8	130	60
<b>3472</b>	E10 x E12	150	60
<b>3473</b>	E14 x E18	190	60
<b>3474</b>	E20 x E24	230	60

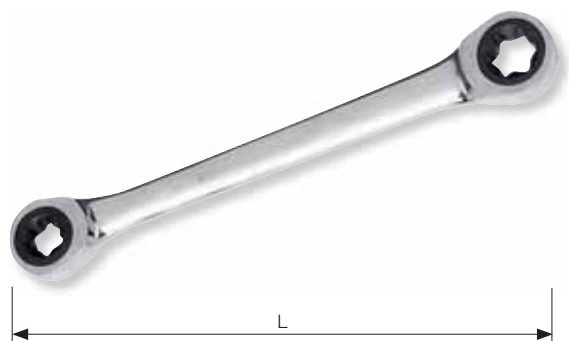

**External TX double ring ratchet wrench set**  
flat

**Juego de llaves de estrella doble con carraca TX exterior**  
*planas*

*planas*

**Jogo de chaves luneta com roquete TX exterior**  
direitas

Art.	
<b>3470</b>	E6 x E8 - E10 x E12 - E14 x E18 - E20 x E24

**DOUBLE RING CLICKRAFT**

**4**  
PCS



250 x 110 x 35 mm

**Ratchet combination wrench**  
reversible

**Llave combinada con carraca**  
*reversible*

**Chave boca-luneta com roquete**  
reversível

Art.	Ø mm	D mm	L mm	Ø
<b>3404-08</b>	8	16.8	140	60
<b>3404-09</b>	9	18.2	149	60
<b>3404-10</b>	10	20.1	159	72
<b>3404-11</b>	11	21.5	165	72
<b>3404-12</b>	12	23.0	170	72
<b>3404-13</b>	13	25.1	180	72
<b>3404-14</b>	14	27.1	190	72
<b>3404-15</b>	15	29.0	200	72
<b>3404-16</b>	16	30.6	208	72
<b>3404-17</b>	17	31.8	225	72
<b>3404-18</b>	18	32.3	236	72
<b>3404-19</b>	19	34.1	248	75
<b>3404-20</b>	20	41.7	290	72
<b>3404-21</b>	21	41.7	290	72
<b>3404-22</b>	22	41.7	290	72
<b>3404-24</b>	24	48.0	330	72

**REVERSIBLE CLICKRAFT**



L

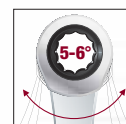
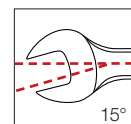
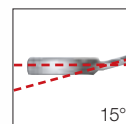
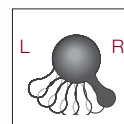



**Ratchet combination wrench set**

reversible

**Juego de llaves combinadas con carraca**

reversibles

**Jogo de chaves boca-luneta com roquete**

reversíveis

4  
PCS



Art.	mm
3404-50	10-13-17-19

**Ratchet combination wrench set**

reversible

**Juego de llaves combinadas con carraca**

reversibles

**Jogo de chaves boca-luneta com roquete**

reversíveis

6  
PCS



Art.	mm
3404-51	8-10-12-13-17-19

**Ratchet combination wrench set**

reversible

**Juego de llaves combinadas con carraca**

reversibles

**Jogo de chaves boca-luneta com roquete**

reversíveis

12  
PCS



↕ 325 x 185 x 56 mm

Art.	mm
3404-54	8-9-10-11-12-13-14-15-16-17-18-19



**COMPLETO**

Ratchet combination wrench case  
reversible

*Estuche de llaves combinadas con carraca*  
reversibles

Jogo de chaves boca-luneta com roquete  
em mala  
reversíveis

14  
PCS



421 x 200 x 68 mm

Art.	mm
<b>4900-47K</b>	8-9-10-11-12-13-14-15-16-17-18-19-22-24

4-in-1 double ring ratchet wrench  
reversible

*Llave poligonal doble con carraca 4-en-1*  
reversible

Chave luneta dupla com roquete 4-em-1  
reversíveis

QUAD REVERSIBLE **CLICKRAFT**

Art.	mm	L mm	mm
<b>3404-0813</b>	8 x 10 mm 12 x 13 mm	160	72 x 72
<b>3404-1019</b>	10 x 13 mm 17 x 19 mm	200	72 x 75
<b>3404-1619</b>	16 x 17 mm 18 x 19 mm	230	72 x 75
<b>3404-51612</b>	5/16" x 3/8" 7/16" x 1/2"	160	72 x 72
<b>3404-91634</b>	9/16" x 5/8" 11/16" x 3/4"	210	72 x 75



4in1

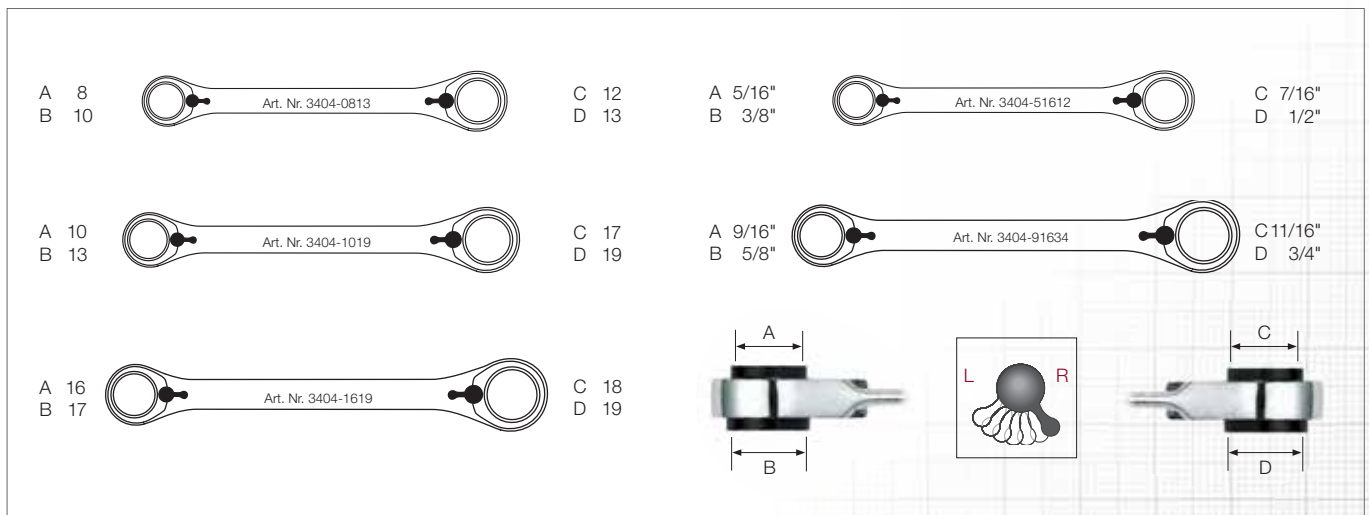

**4-in-1 double ring ratchet wrench set**  
reversible

**Juego de llaves poligonales doble con carraca**  
**4-en-1**  
reversibles

**Jogo de chaves luneta dupla com roquete**  
**4-em-1**  
reversíveis

**2**  
PCS



↕ 250 x 110 x 35 mm

Art.	○ mm
<b>3404-4x2</b>	8 x 10 / 12 x 13 16 x 17 / 18 x 19

**Ratchet combination wrench**  
flexible

**Llave combinada con carraca**  
flexible

**Chave boca-luneta com roquete**  
flexível

Art.	○ mm	D mm	L mm	○
<b>3403-08</b>	8	17.0	140	60
<b>3403-09</b>	9	19.0	149	60
<b>3403-10</b>	10	20.0	158	72
<b>3403-11</b>	11	22.0	165	72
<b>3403-12</b>	12	23.0	171	72
<b>3403-13</b>	13	25.0	176	72
<b>3403-14</b>	14	27.5	190	72
<b>3403-15</b>	15	29.0	199	72
<b>3403-16</b>	16	30.0	208	72
<b>3403-17</b>	17	32.0	225	72
<b>3403-18</b>	18	34.0	236	72
<b>3403-19</b>	19	34.3	248	75
<b>3403-20</b>	20	42.0	290	72
<b>3403-21</b>	21	42.0	290	72
<b>3403-22</b>	22	42.0	290	72
<b>3403-24</b>	24	49.0	333	72

FLEX CLICKRAFT

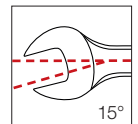
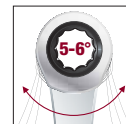

**Ratchet combination wrench set**

flexible

**Juego de llaves combinadas con carraca**

flexibles

**Jogo de chaves boca-luneta com roquete**

flexíveis

Art.	mm
<b>3403-51</b>	8-10-12-13-17-19

**6**  
PCS



**Ratchet combination wrench set**

flexible

**Juego de llaves combinadas con carraca**

flexibles

**Jogo de chaves boca-luneta com roquete**

flexíveis

Art.	mm
<b>3403-54</b>	8-9-10-11-12-13-14-15-16-17-18-19

**12**  
PCS



↕ 325 x 185 x 56 mm

**Ratchet combination wrench case**

flexible

**Estuche de llaves combinadas con carraca**

flexibles

**Jogo de chaves boca-luneta com roquete em mala**

flexíveis

Art.	mm
<b>4900-46K</b>	8-9-10-11-12-13-14-15-16-17-18-19-22-24

**14**  
PCS



↕ 421 x 200 x 68 mm





**Ratchet combination wrench**

flexible, Stubby

**Llave combinada con carraca**

flexible, corta

**Chave boca-luneta com roquete**

flexível, curta

Art.	Ø mm	D mm	L mm	Ø
<b>3403-08S</b>	8	17.0	88	60
<b>3403-10S</b>	10	20.0	94	72
<b>3403-11S</b>	11	22.0	102	72
<b>3403-12S</b>	12	23.0	105	72
<b>3403-13S</b>	13	25.0	107	72
<b>3403-14S</b>	14	27.5	114	72

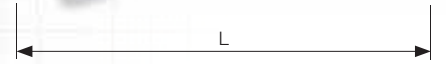

**Double ring ratchet wrench set**

flexible

**Juego de llaves poligonales doble con carraca**

flexibles

**Jogo de chaves luneta dupla com roquete**

flexíveis

\*Option / Opcionales / Opção

- Art. 3691 1/4" x 10 mm
- Art. 3692 3/8" x 13 mm
- Art. 3693 1/2" x 19 mm
- Art. 2694 1/4" x 10 mm



Art.	Ø mm
<b>3450-51</b>	8 x 9 - 10 x 11 - 12 x 14 - 13 x 15 - 16 x 18 - 17 x 19

**6**  
PCS



305 x 140 x 42 mm



## Ratchet combination wrench

swivelling laterally stepless up to 180° for ratcheting even at badly accessible places. Locking knob for fixation of the angle

### Llave combinada con carraca

oscilante lateralmente sin escalonamiento hasta 180° para trabajar en sitios de muy difícil acceso. Botón de bloqueo para fijar el ángulo

### Chave boca-luneta com roquete

angular sem escala até 180° lateral para trabalhar em sítios de acesso limitado. Sistema de bloqueio para o ângulo

Art.	Ø mm	D mm	L mm	Ø
<b>3402-08</b>	8	17.0	151	60
<b>3402-09</b>	9	17.9	164	60
<b>3402-10</b>	10	19.8	179	72
<b>3402-11</b>	11	21.6	194	72
<b>3402-12</b>	12	23.0	205	72
<b>3402-13</b>	13	24.7	219	72
<b>3402-14</b>	14	26.3	233	72
<b>3402-15</b>	15	28.4	247	72
<b>3402-16</b>	16	30.5	257	72
<b>3402-17</b>	17	31.8	272	72
<b>3402-18</b>	18	33.2	287	72
<b>3402-19</b>	19	34.0	303	75

## ANGLE CLICKRAFT



## Ratchet combination wrench case

swivelling laterally stepless up to 180° for ratcheting even at badly accessible places. Locking knob for fixation of the angle

### Estuche de llaves combinadas con carraca

oscilantes lateralmente sin escalonamiento hasta 180° para trabajar en sitios de muy difícil acceso. Botón de bloqueo para fijar el ángulo

### Jogo de chaves boca-luneta com roquete em mala

angular e sem escala até 180° lateral para trabalhar em sítios de acesso limitado. Sistema de bloqueio para o ângulo

\*Option / Opcionales / Opção



14  
PCS



## COMPLETO



421 x 200 x 68 mm

Art.	Ø mm
<b>4900-41K</b>	8-9-10-11-12-13-14-15-16-17-18-19-22-24



3.019

Socket- and bit-adapter set

*Juego de adaptador para llaves de vaso y portapuntas*

Jogo de adaptadores para chaves de caixa e bits

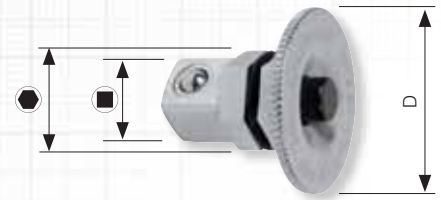

Art.	mm	□ + ○	D mm
<b>3691</b>	10	1/4" + 1/4"	20



Socket adapter

*Adaptador para llaves de vaso*

Adaptador para chaves de caixa

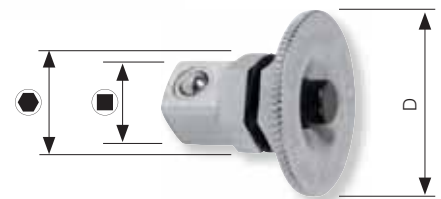

Art.	mm	□	D mm
<b>3692</b>	13	3/8"	25

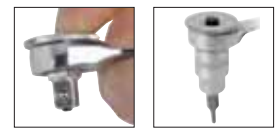

Socket adapter

*Adaptador para llaves de vaso*

Adaptador para chaves de caixa

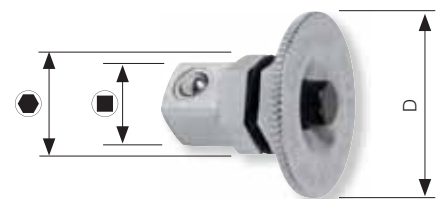

Art.	mm	□	D mm
<b>3693</b>	19	1/2"	35



Bit-adapter

*Portapuntas*

Adaptador de bit



Art.	mm	○	L mm
<b>2694</b>	10	1/4"	20



## Combination wrench

mirror polished

### Llave combinada

pulido brillante

### Chave de boca-luneta

polida

Art.	Ø mm	L mm
3505	5.5	127
3506	6	127
3507	7	134
3508	8	140
3509	9	150
3510	10	159
3511	11	165
3512	12	172
3513	13	179
3514	14	191
3515	15	199
3516	16	206
3517	17	225
3518	18	235
3519	19	248
3520	20	272
3521	21	272
3522	22	291
3523	23	315
3524	24	315
3525	25	335
3526	26	335
3527	27	358
3528	28	402
3530	30	425
3532	32	425
3534	34	375
3536	36	395
3538	38	400
3541	41	435
3546M	46	485
3550M	50	525





### Combination wrench set

mirror polished, with plastic carrying holder

### Juego de llaves combinadas

pulido brillante, en petaca con asa de material plástico

### Jogo de chaves de boca-luneta

polidas, com suporte plástico

**10**  
PCS

Art.	mm
<b>3556</b>	8-9-10-11-12-13 14-15-17-19



### Combination wrench set

mirror polished

### Juego de llaves combinadas

pulido brillante

### Jogo de chaves de boca-luneta

polidas

**13**  
PCS

Art.	mm
<b>3550</b>	8-9-10-11-12-13-14 15-16-17-18-19-22



### Combination wrench set

mirror polished

### Juego de llaves combinadas

pulido brillante

### Jogo de chaves de boca-luneta

polidas

**18**  
PCS

Art.	mm
<b>3557</b>	5.5-6-7-8-9-10-11-12-13-14 15-16-17-18-19-20-21-22
<b>3557R</b>	5.5-6-7-8-9-10-11-12-13-14 15-16-17-18-19-20-21-22

Art. 3557



Art. 3557R

Canvas

### Combination wrench set

mirror polished

### Juego de llaves combinadas

pulido brillante

### Jogo de chaves de boca-luneta

polidas

**4**  
PCS

Art.	mm
<b>3558</b>	24-27-30-32
<b>3558R</b>	24-27-30-32



Art. 3558



Art. 3558R

Canvas

### Combination wrench set

mirror polished, with plastic carrying holder

### Juego de llaves combinadas

pulido brillante, en petaca con asa de material plástico

### Jogo de chaves de boca-luneta

polidas, com suporte plástico



Art.	mm
<b>3559</b>	34-36-38-41-46-50

### Combination wrench set

of stainless steel

### Juego de llaves combinadas

en acero inoxidable

### Jogo de chaves de boca-luneta

em aço inoxidável

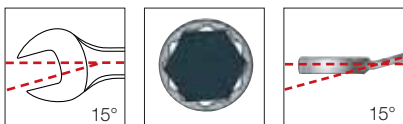

Art.	mm
<b>3503-56</b>	8-10-11-12-13-14-15-17-19

### Inch combination wrench

mirror polished

### Llave combinada pulgadas

pulido brillante

### Chave de boca-luneta polegada

polida

Art.	inch	L mm
<b>3587</b>	1/4"	126
<b>3588</b>	5/16"	139
<b>3589</b>	3/8"	160
<b>3590</b>	7/16"	166
<b>3591</b>	1/2"	178
<b>3592</b>	9/16"	190
<b>3593</b>	5/8"	208
<b>3594</b>	11/16"	226
<b>3595</b>	3/4"	250
<b>3596</b>	13/16"	271
<b>3597</b>	7/8"	294
<b>3598</b>	15/16"	314
<b>3599</b>	1"	335

CrV

NEW  
NUEVO  
NOVO

**JUMBO**

6  
PCS



inox

9  
PCS

NEW  
NUEVO  
NOVO



inch



**Inch combination wrench set**

mirror polished

**Juego de llaves combinadas en pulgadas**

pulido brillante

**Jogo de chaves de boca-luneta polegadas**

polidas

Art.	inch
<b>3585</b>	3/8"-7/16"-1/2"-9/16"-5/8"-11/16" 3/4"-13/16"-7/8"-15/16"-1"
<b>3585R</b>	3/8"-7/16"-1/2"-9/16"-5/8"-11/16" 3/4"-13/16"-7/8"-15/16"-1"

inch

11  
PCS



Art. 3585



Art. 3585R

Canvas

**Inch combination wrench case**

mirror polished, with 2 reversible ring ratchet wrenches 4-in-1

**Estuche de llaves combinadas en pulgadas**

pulido brillante, con 2 llaves poligonales dobles con carraca reversible 4-en-1

**Mala de chaves de boca-luneta polegadas**

polidas, com 2 chaves luneta com roquete reversível 4-em-1

4in1

**REVERSIBLE CLICKRAFT**

A 5/16" B 3/8" Art. Nr. 3404-51612 A 7/16" B 1/2"

A 9/16" B 5/8" Art. Nr. 3404-91634 A 11/16" B 3/4"

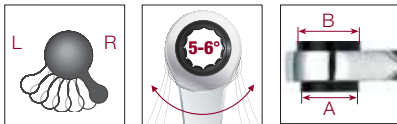

Art.	inch
<b>4900-30K</b>	1/4"-5/16"-3/8"-7/16"-1/2"-9/16"-5/8" 11/16"-3/4"-13/16"-7/8"-15/16"-1"

inch

15  
PCS



402 x 173 x 48 mm



### COMBI universal combination wrench set

mirror polished

### Juego de llaves combinadas universales COMBI

pulido brillante

### Jogo de chaves mistas universais COMBI

polidas

18  
PCS



mm  
inch



E-TX



XZN

COMBI

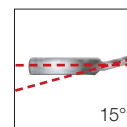

15°

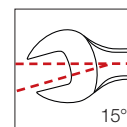

15°

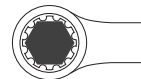

Art.	mm	inch	TX	XZN
<b>3501-57</b>				
	5,5-22 mm	7/32"-7/8"	E8-E24	M8-M18
<b>3501-57R</b>				



Art. 3501-57



mm

5.5-6-7-8-9-10-11-12-13-14-15  
16-17-18-19-20-21-22 mm



inch

7/32"-5/16"-11/32"-3/8"-7/16"-15/32"-1/2"  
19/32"-5/8"-3/4"-25/32"-13/16"-7/8"



TX

E8-E10-E12-E14-E16  
E18-E20-E22-E24



XZN

M8-M10-M12-M14-M16-M18



Art. 3501-57R

Canvas

### COMBI universal combination wrench set

mirror polished

### Juego de llaves combinadas universales COMBI

pulido brillante

### Jogo de chaves mistas universais COMBI

polidas

4  
PCS



mm  
inch



E-TX



XZN

COMBI

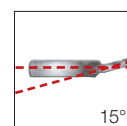

15°

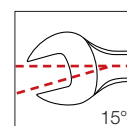

15°

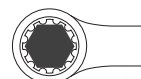

Art.	mm	inch	TX
<b>3501-58</b>			
	24-32 mm	15/16"-1-1/4"	E30-E40
<b>3501-58R</b>			



Art. 3501-58



Art. 3501-58R

Canvas



mm

24-27-30-32 mm



inch

15/16"-1-1/16"-1-1/8"-1-1/4"



TX

E30-E34-E38-E40



**Double open end wrench**

mirror polished

**Llave fija**

pulido brillante

**Chave de bocas**

polida

Art.	○ mm	L mm
<b>3560</b>	6 x 7	125
<b>3561</b>	8 x 9	137
<b>3562</b>	10 x 11	149
<b>N</b> <b>3551</b>	10 x 13	162
<b>3563</b>	12 x 13	162
<b>3564</b>	14 x 15	188
<b>3565</b>	16 x 17	203
<b>N</b> <b>3552</b>	17 x 19	227
<b>3566</b>	18 x 19	227
<b>3567</b>	21 x 22	252
<b>3568</b>	24 x 27	280
<b>3569</b>	30 x 32	310
<b>3579</b>	36 x 41	350
<b>N</b> <b>3583</b>	46 x 50	440
<b>N</b> <b>3586</b>	55 x 60	505



DIN 3110 / ISO 1085, 3318, 10102

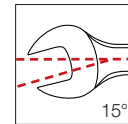

**Double open end wrench set**

mirror polished

**Juego de llaves fijas**

pulido brillante

**Jogo de chaves de bocas**

polidas

Art.	○ mm
<b>3570</b>	6x7-8x9-10x11-12x13-14x15 16x-17-18x19-21x22
<b>3570R</b>	6x7-8x9-10x11-12x13-14x15 16x-17-18x19-21x22

**8**  
PCS



Art. 3570



Art. 3570R

Canvas

## Adjustable angle wrench

with scale

### Llave ajustable

con escala

### Chave crescente

com escala

Art.	Ø mm	L mm / inch
<b>2404</b>	0 - 14	100 / 4"
<b>2406</b>	0 - 20	150 / 6"
<b>2408</b>	0 - 25	200 / 8"
<b>2410</b>	0 - 30	250 / 10"
<b>2412</b>	0 - 35	300 / 12"
<b>2415</b>	0 - 45	375 / 15"
<b>2418</b>	0 - 55	450 / 18"



## Adjustable angle wrench

with 2-component handle and scale

### Llave ajustable

con mango bi-material y escala

### Chave crescente

com punho em bi-matéria e escala

Art.	Ø mm	L mm / inch
<b>3571</b>	0 - 13	100 / 4"
<b>3572</b>	0 - 20	150 / 6"
<b>3573</b>	0 - 25	200 / 8"
<b>3574</b>	0 - 30	250 / 10"
<b>3575</b>	0 - 35	300 / 12"
<b>3576</b>	0 - 45	375 / 15"



**ergokraft**



### One for many – the Duo Quick universal wrench

with quick adjustment. Release the jaw with one easy pull on the knob. Push the jaw to the screw with the thumb – the jaw is firmly and accurately fixed to the millimeter/inch and shows the screw size on the metric and the inch scale. The Duo Quick wrench replaces every conventional metric or inch wrench up to 24 mm / 1 inch.

### Uno para muchos – la llave universal Duo Quick

con ajuste rápido. Libera las bocas simplemente al tirar del botón. Empuje con el dedo pulgar la boca hasta la fijación firme del tornillo, indica la medida del tornillo en escala métrica/pulgada. La llave Duo Quick reemplaza cualquier llave convencional métrica o en pulido, hasta 24 mm / 1".

### Uma para muitas – A chave crescente Duo Quick

com ajuste rápido. Liberte a maxila com um simples carregar de botão. Acerte a maxila com o parafuso – a maxila está firme e certa na escala de milímetros/polegadas, indicando assim a medida do parafuso na escala. A chave Duo Quick substitui qualquer chave crescente métrica ou polegadas até 24 mm / 1 polegada.

automatic



Art.	mm / inch	L mm / inch
<b>3582</b>	0 - 26 / 0 - 1"	200 / 8"



Video  
[KRAFTWERKtools.com/video/3582](https://www.kraftwerktools.com/video/3582)

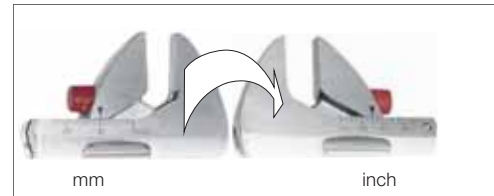
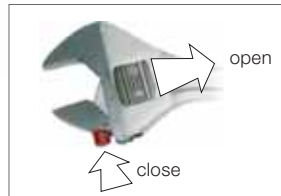

### Adjustable ratchet angle wrench

for the fast tightening and loosening of 4-point and 6-point screws/nuts without disengaging the wrench while working. Ratcheting on/off switch to select movable or fixed wrench head. Ergonomic 2-component handle.

### Llave ajustable con carraca

para apretar o aflojar los tornillos de 4-6 puntos sin retirar la llave mientras se trabaja. Provisto de un sistema revolucionario para seleccionar cabeza de la llave fija o móvil. Mango ergonómico bimatérial.

### Chave crescente com roquete

para apertar e desapertar parafusos com 4 e 6 lados sem retirar a chave. Com um sistema revolucionário para soltar a mandíbula. Punho ergonómico em bi-matéria.

Art.	mm / inch	L mm / inch
<b>3577</b>	0 - 25 / 0 - 1"	210 / 8.27"

CrMo

ergokraft

NEW  
NUEVO  
NOVO

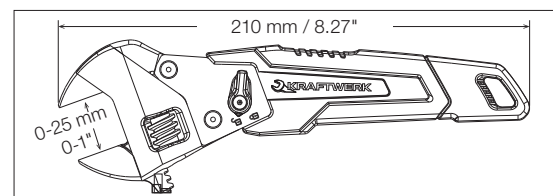
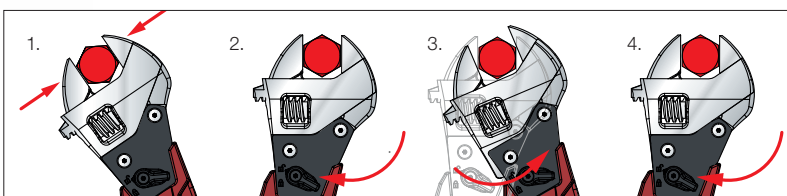

## Double offset ring wrench

mirror polished

### Llave estrella dos bocas

pulido brillante

### Chave de luneta

polida

Art.	○ mm	L mm
<b>3480</b>	6 x 7	165
<b>3481</b>	8 x 9	180
<b>3482</b>	10 x 11	199
<b>3483</b>	12 x 13	218
<b>3484</b>	14 x 15	238
<b>3485</b>	16 x 17	262
<b>3486</b>	18 x 19	287
<b>3487</b>	20 x 22	317
<b>3488</b>	21 x 23	329
<b>3489</b>	24 x 27	346
<b>3490</b>	25 x 28	346
<b>3491</b>	30 x 32	369
<b>3492</b>	36 x 41	460
<b>N</b> <b>3493</b>	46 x 50	520
<b>N</b> <b>3494</b>	55 x 60	620

## Double offset ring wrench set

mirror polished

### Juego de llaves estrella dos bocas

pulido brillante

### Jogo de chaves luneta

polidas

Art.	○ mm
<b>3497</b>	6x7-8x9-10x11-12x13-14x15 16x17-18x19-21x22
<b>3497R</b>	6x7-8x9-10x11-12x13-14x15 16x17-18x19-21x22



DIN 838 / ISO 1085, 3318, 10104

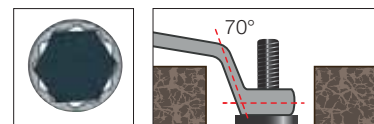

**8**  
PCS



Art. 3497



Art. 3497R

Canvas



**Double offset ring wrench set**

mirror polished

**Juego de llaves estrella dos bocas**

pulido brillante

**Jogo de chaves luneta**

polidas

Art.	Ø mm
<b>3498</b>	21x23 - 24x27 - 25x28 - 30x32
<b>3498R</b>	21x23 - 24x27 - 25x28 - 30x32

**4**  
PCS



Art. 3498



Art. 3498R

Canvas

**Double offset ring wrench case**

mirror polished

**Estuche de llaves estrella dos bocas**

pulido brillante

**Mala de chaves luneta**

polidas

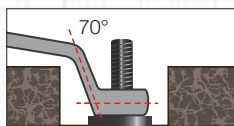

Art.	Ø mm
<b>4900-15K</b>	6x7-8x9-10x11-12x13-14x15-16x17 18x19-20x22-21x23-24x27-30x32

**11**  
PCS



**COMPLETO**

421 x 200 x 68 mm

**External TX double ring wrench**

flat, mirror polished

**Llave de estrella doble TX exterior**

recta, pulido brillante

**Chave de luneta TX exterior**

direita, polida



Art.	⊗ E	L mm
<b>3546</b>	E6 x E8	112
<b>3547</b>	E10 x E12	140
<b>3548</b>	E14 x E18	180
<b>3549</b>	E20 x E24	223



### External TX double ring wrench set

flat, mirror polished

### Juego de llaves de estrella doble TX exterior

rectas, pulido brillante

### Jogo de chaves de luneta TX exterior

direitas, polidas



4  
PCS



Art.	☼ E
<b>3545</b>	E6xE8 - E10xE12 - E14xE18 - E20xE24

### Flare nut wrench

mirror polished

### Llave para racores

pulido brillante

### Chave de luneta aberta

polida

Art.	mm	inch	L mm
<b>3580-00</b>	9 x 11		173
<b>3580-01</b>	10 x 12		175
<b>3580-02</b>	13 x 14		208
<b>3580-03</b>	15 x 17		245
<b>3580-04</b>		3/8" x 7/16"	173
<b>3580-05</b>		1/2" x 9/16"	208
<b>3580-06</b>		5/8" x 11/16"	250



### Flare nut wrench set

mirror polished

### Juego de llaves para racores

pulido brillante

### Jogo de chaves de luneta aberta

polidas

7  
PCS

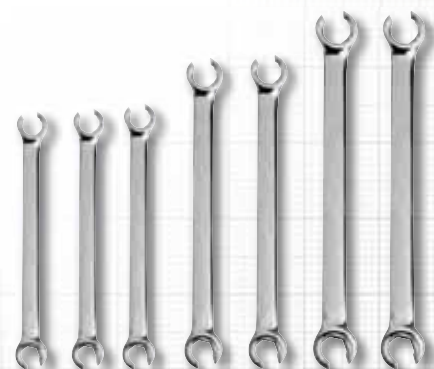

Art.	mm / inch
<b>3580</b>	9x11 - 10x12 - 13x14 - 15x17 3/8"x7/16" - 1/2"x9/16" - 5/8"x11/16"

**Elbow milled angle socket wrench 6 x 6 point**

mirror polished

**Llave de pipa abierta 6 x 6**

pulido brillante

**Chave de cachimbo aberta 6 x 6**

polida



NF ISO 2236

Art.	Ø mm	L ± mm
2597-06	6	102 ± 3
2597-07	7	106 ± 3
2597-08	8	114 ± 3
2597-09	9	122 ± 3
2597-10	10	129 ± 3
2597-11	11	136 ± 3
2597-12	12	144 ± 4
2597-13	13	152 ± 4
2597-14	14	160 ± 4
2597-15	15	169 ± 4
2597-16	16	178 ± 4
2597-17	17	187 ± 4
2597-18	18	195 ± 4
2597-19	19	204 ± 4
2597-20	20	212 ± 4
2597-21	21	221 ± 5
2597-22	22	230 ± 5
2597-23	23	240 ± 5
2597-24	24	250 ± 5
2597-25	25	260 ± 5
2597-26	26	270 ± 5
2597-27	27	280 ± 5
2597-28	28	290 ± 5
2597-29	29	300 ± 5
2597-30	30	310 ± 5
2597-32	32	330 ± 5

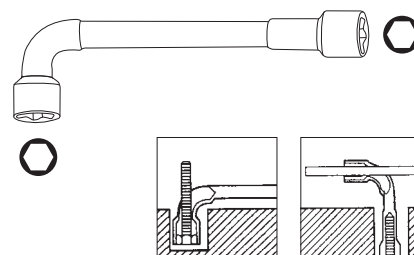

## Elbow milled angle socket wrench 12 x 6 point

mirror polished

### Llave de pipa abierta 12 x 6

pulido brillante

### Chave de cachimbo aberta 12 x 6

polida



NF ISO 2236

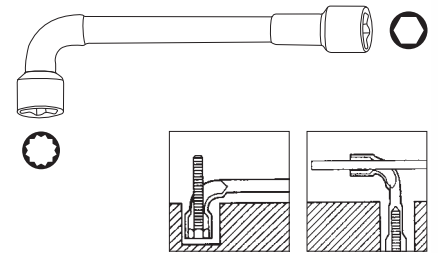

Art.	Ø mm	L ± mm
<b>2598-06</b>	6	102 ± 3
<b>2598-07</b>	7	106 ± 3
<b>2598-08</b>	8	114 ± 3
<b>2598-09</b>	9	122 ± 3
<b>2598-10</b>	10	129 ± 3
<b>2598-11</b>	11	136 ± 3
<b>2598-12</b>	12	144 ± 4
<b>2598-13</b>	13	152 ± 4
<b>2598-14</b>	14	160 ± 4
<b>2598-15</b>	15	169 ± 4
<b>2598-16</b>	16	178 ± 4
<b>2598-17</b>	17	187 ± 4
<b>2598-18</b>	18	195 ± 4
<b>2598-19</b>	19	204 ± 4
<b>2598-20</b>	20	212 ± 4
<b>2598-21</b>	21	221 ± 5
<b>2598-22</b>	22	230 ± 5
<b>2598-23</b>	23	240 ± 5
<b>2598-24</b>	24	250 ± 5
<b>2598-25</b>	25	260 ± 5
<b>2598-26</b>	26	270 ± 5
<b>2598-27</b>	27	280 ± 5
<b>2598-28</b>	28	290 ± 5
<b>2598-29</b>	29	300 ± 5
<b>2598-30</b>	30	310 ± 5
<b>2598-32</b>	32	330 ± 5
<b>2598-34</b>	34	350 ± 5



**Elbow milled angle socket wrench set**





mirror polished

**Juego de llaves de pipa abiertas**

pulido brillante

**Jogo de chaves de cachimbo abertas**

polidas

Art.		mm
<b>2597-99</b>	 	8-10-11-12-13-14-16-17-18-19
<b>2598-99</b>	 	8-10-11-12-13-14-16-17-18-19



**10**  
PCS



**Elbow milled open socket wrench case**

mirror polished





**Estuche de llaves de pipa abiertas**

pulido brillante

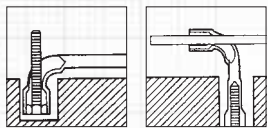
**Mala de chaves de cachimbo abertas**

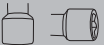
polidas



Art.		mm
<b>4900-48K</b>	 	8-9-10-11-12-13-14-15 16-17-18-19-22
<b>4900-18K</b>	 	8-9-10-11-12-13-14-15 16-17-18-19-22



**13**  
PCS



**COMPLETO**

421 x 200 x 68 mm

**Double flexible socket wrench**

mirror polished

**Llave de vaso doble articulada**

pulido brillante

**Chave de caixa articulada**

polida

Art.	mm	L mm
<b>2590-0809</b>	8 x 9	176
<b>2590-1011</b>	10 x 11	200
<b>2590-1213</b>	12 x 13	216
<b>2590-1415</b>	14 x 15	240
<b>2590-1617</b>	16 x 17	255
<b>2590-1819</b>	18 x 19	270

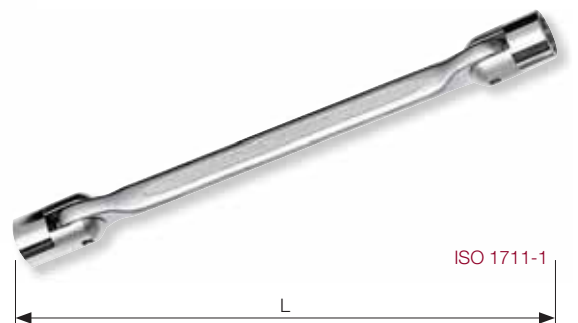

ISO 1711-1

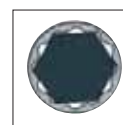

### Double flexible wrench for sockets

mirror polished

*Llave doble articulada para llaves de vaso*

*pulido brillante*

**Chave dupla articulada para chaves de caixa**

polida

Art.	■	L mm
<b>2590-3814</b>	1/4" x 3/8"	255

1/4"

3/8"



### Universal joint spark plug wrench

*Llave de bujia articulada*

**Chave de velas articulada**

Art.	○ mm	L mm
<b>2591-16</b>	16	240
<b>2591-21</b>	21	245

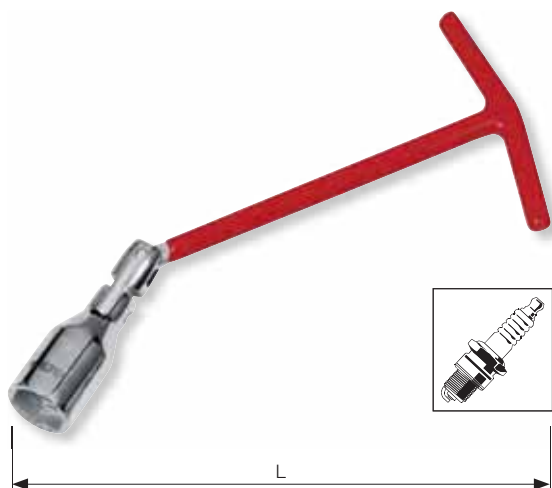

### L type wheel wrench with double socket

extensible

*Llave ruedas en L con llave de vaso doble*

*extensible*

**Chave de rodas tipo L com chave dupla**

extensível

Art.	○ mm	L 1 mm	L 2 mm
<b>2585-1719</b>	17 x 19	365	525

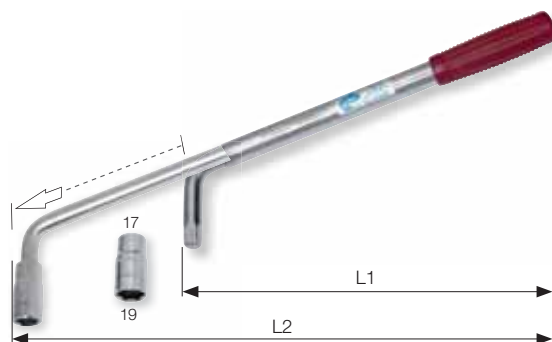

### Cross rim wrench

*Llave ruedas cruz*

**Chave de rodas em cruz**

Art.	○ mm	■	L mm
<b>2585-12</b>	17-19-22	1/2"	375
<b>2585-34</b>	24-27-32	3/4"	625



### T-type universal socket

extra long

### Llave de vaso en T muletilla

extra larga

### Chave de caixa cabo em "T"

extra longa

**XXL**

Art.	Ø mm	L mm
2592-08	8	390
2592-09	9	390
2592-10	10	495
2592-11	11	495
2592-12	12	495
2592-13	13	495
2592-14	14	495
2592-15	15	495
2592-16	16	495
2592-17	17	495
2592-18	18	495
2592-19	19	495

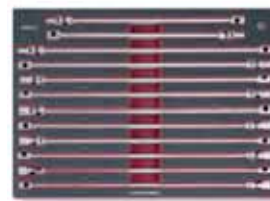

Art. 4902-07  
1.057

### Double end tubular socket wrench

light serie

### Llave de tubo de dos bocas

serie ligera

### Chave de tubos direita

série ligeira

Art.	Ø mm	Ø mm	L mm
2589-0607	6 x 7	5	108
2589-0809	8 x 9	5	110
2589-1011	10 x 11	5	122
2589-1213	12 x 13	5	142
2589-1415	14 x 15	8	143
2589-1617	16 x 17	10	146
2589-1819	18 x 19	10	158
2589-2022	20 x 22	10	175
2589-2123	21 x 23	12	175
2589-2427	24 x 27	12	185
2589-2528	25 x 28	12	190
2589-3032	30 x 32	12	205



## Double end tubular socket wrench set

light serie

### Juego de llaves de tubo de dos bocas

serie ligera

### Jogo de chaves de tubos direita

série ligeira

Art.	Ø mm	Ø mm
<b>2589-01</b>	6x7-8x9-10x11-12x13 14x15-16x17-18x19-20x22	5-8-10

9  
PCS



Canvas

## Double end tubular socket wrench set

light serie

### Juego de llaves de tubo de dos bocas

serie ligera

### Jogo de chaves de tubos direita

série ligeira

Art.	Ø mm	Ø mm
<b>2589-02</b>	21x23 - 24x27 - 25x28 - 30x32	10+12

6  
PCS



Canvas

## Stepped tommy bar

for double end tubular socket wrenches

### Pasador

para llaves de tubo de dos bocas

### Barra T escalonada

para chaves de tubos direita

Art.	Ø mm	L mm
<b>2599-3457</b>	3.5 - 4.5 - 5.5 - 7.5	165
<b>2589-5810</b>	5 - 8 - 10	190
<b>2599-1012</b>	10 - 12	210

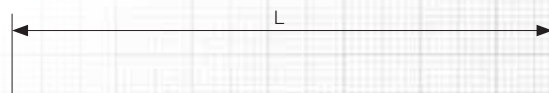



### Double end tubular socket wrench

heavy duty serie, made by CNC-machining

### Llave de tubo de dos bocas

serie fuerte, fabricada con precisión CNC

### Chave de tubos direita

série maciça, fabricada com precisão CNC

Art.	mm	Ø mm	L mm
2599-0607	6 x 7	3.5	105
2599-0809	8 x 9	3.5	110
2599-1011	10 x 11	4.5	120
2599-1213	12 x 13	5.5	138
2599-1415	14 x 15	5.5	145
2599-1617	16 x 17	8	152
2599-1819	18 x 19	8	162
2599-2022	20 x 22	10	175
2599-2123	21 x 23	10	185
2599-2427	24 x 27	12	195
2599-2528	25 x 28	12	205
2599-3032	30 x 32	12	210

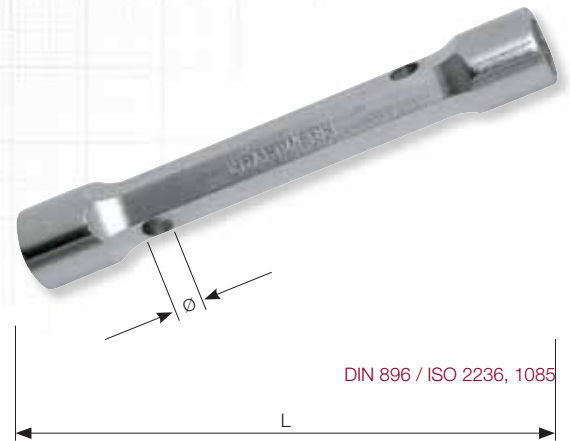

### Double end tubular socket wrench set

heavy duty serie, made by CNC-machining

### Juego de llaves de tubo de dos bocas

serie fuerte, fabricada con precisión CNC

### Jogo de chaves de tubos direita

série maciça, fabricada com precisão CNC

Art.	mm	Ø mm
2599-01	6x7-8x9-10x11-12x13 14x15-16x17-18x19-20x22	5-8-10

9  
PCS



Canvas

### Double end tubular socket wrench set

heavy duty serie, made by CNC-machining

### Juego de llaves de tubo de dos bocas

serie fuerte, fabricada con precisión CNC

### Jogo de chaves de tubos direita

série maciça, fabricada com precisão CNC

Art.	mm	Ø mm
2599-02	21x23 - 24x27 - 25x28 - 30x32	10+12

6  
PCS



Canvas

### Quick- + Flex Universal wrench set

One ergonomic 2-component handle for 12 open end and 12 ring wrench heads, interchangeable in seconds. Application of each size as straight or flexible head wrench.



### Llave universal Quick- + Flex

Un solo mango ergonómico bimatériau para 12 bocas de llaves abiertas y 12 bocas cerradas, intercambiables en segundos. Uso de cada una como llaves rectas o flexibles.

### Chave universal Quick- + Flex

Cabo ergonómico bi-matéria para 12 cabeças luneta e 12 de Bocas, intercambiáveis em segundos. Utilização como chave direita ou flexível.



### Starter set

with the each 6 most common sizes of open end and ring wrench heads in the bottom of the case

### Juego básico

con las 6 llaves con bocas cerradas y abiertas de las medidas más usadas

### Conjunto de base

com as 6 medidas mais usadas de chaves de bocas e de luneta



	6	8-10-12-13-17-19 mm
	6	8-10-12-13-17-19 mm
	1	180 mm

Art.
<b>3584-1</b>

**Extension set**

with further 6 sizes placed in the case cover of set 3584-1

**12**  
PCS

**Juego de ampliación**

con 6 llaves de medidas más en la tapa del estuche

**Conjunto de extensão**

com 6 medidas adicionais e contem espaço próprio na tampa



6 9-11-14-15-16-18 mm



6 9-11-14-15-16-18 mm



Art.

**3584-2**

**Complete set**

containing 3584-1 and 3584-2

**25**  
PCS

**Juego completo**

compuesto con 3584-1 y 3584-2

**Jogo completo**

composto por 3584-1 e 3584-2



12 8-9-10-11-12-13-14-15-16-17-18-19 mm



12 8-9-10-11-12-13-14-15-16-17-18-19 mm



1 180 mm



320 x 220 x 70 mm

Art.

**3584**

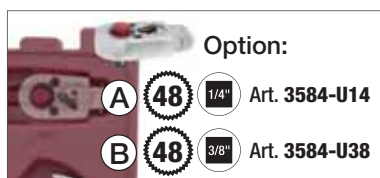

Ring wrench head  
*Cabeza llave poligonal*  
 Cabeça de luneta

Art.	⊙ mm
3584-R08	8
3584-R09	9
3584-R10	10
3584-R11	11
3584-R12	12
3584-R13	13
3584-R14	14
3584-R15	15
3584-R16	16
3584-R17	17
3584-R18	18
3584-R19	19



Open end wrench head  
*Cabeza llave fija*  
 Cabeça de bocas

Art.	⊙ mm
3584-G08	8
3584-G09	9
3584-G10	10
3584-G11	11
3584-G12	12
3584-G13	13
3584-G14	14
3584-G15	15
3584-G16	16
3584-G17	17
3584-G18	18
3584-G19	19



Reversible ratchet head  
*Cabeza carraca reversible*  
 Cabeça de roquete reservável

Art.	⊙
3584-U14	1/4"
3584-U38	3/8"



48





**Offset hexagon key wrench**

mat chromed

**Llave hexagonal macho acodada**

cromada satinada

**Chave em "L" sextavada interior**

cromada mate

Art.	mm	L mm
<b>3601-1.5</b>	1.5	46.0
<b>3601-2</b>	2.0	52.0
<b>3601-2.5</b>	2.5	58.5
<b>3601-3</b>	3.0	66.0
<b>3601-4</b>	4.0	74.0
<b>3601-5</b>	5.0	84.0
<b>3601-6</b>	6.0	95.0
<b>3601-8</b>	8.0	108.0
<b>3601-10</b>	10.0	121.0



**Offset hexagon key wrench set**

mat chromed

**Juego de llaves hexagonales macho acodadas**

cromadas satinadas

**Jogo de chaves em "L" sextavada interior**

cromadas mate

Art.	mm
<b>3601</b>	1.5-2-2.5-3-4-5-6-8-10



DIN / ISO 2936



### Offset hexagon key wrench set

made of stainless steel

### Juego de llaves hexagonales macho acodadas

en acero inoxidable

### Jogo de chaves em "L" sextavada interior

em aço inoxidável

Art.	mm
3641	1.5-2-2.5-3-4-5-6-8-10



DIN / ISO 2936

NEW  
NUEVO  
NOVO



### Offset ballpoint hexagon key wrench

long, polished and mat chromed

### Llave hexagonal macho acodada con bola

larga, pulida y cromada satinado mate

### Chave em "L" sextavada interior com ponta esférica

longa, polida e cromada mate

Art.	mm	L mm
3602-1.5	1.5	63.5
3602-2	2.0	77.0
3602-2.5	2.5	87.5
3602-3	3.0	93.0
3602-4	4.0	104.0
3602-5	5.0	120.0
3602-6	6.0	141.0
3602-7	7.0	147.0
3602-8	8.0	158.0
3602-10	10.0	180.0

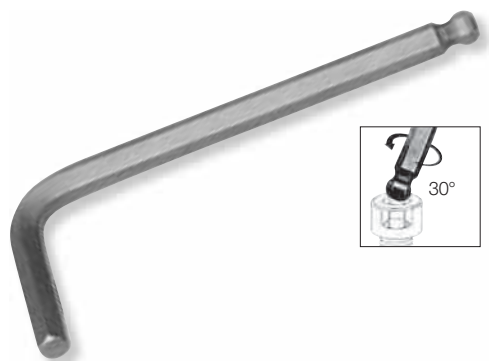

DIN / ISO 2936

### Offset ballpoint hexagon key wrench set

long, polished and mat chromed

### Juego de llaves hexagonales macho acodadas con bola

largas, pulidas y cromadas satinado mate

### Jogo de chaves em "L" sextavada interior com ponta esférica

longas, polidas e cromadas mate

Art.	mm
3602	1.5-2-2.5-3-4-5-6-7-8-10



DIN / ISO 2936



**Offset ballpoint hexagon key wrench set**  
long, made of stainless steel

**Juego de llaves hexagonales macho acodadas con bola**

*largas, en acero inoxidable*

**Jogo de chaves em "L" sextavada interior com ponta esférica**

*longas, em aço inoxidável*



DIN / ISO 2936



Art.	mm
<b>3642</b>	1.5-2-2.5-3-4-5-6-8-10

**Offset ballpoint hexagon key wrench**  
extra long, polished and mat chromed

**Llave hexagonal macho acodada con bola**

*extra larga, pulida y cromada satinado mate*

**Chave em "L" sextavada interior com ponta esférica**

*extra longa, polida e cromada mate*



DIN / ISO 2936

Art.	mm	L mm
<b>3604-1.5</b>	1.5	91.5
<b>3604-2</b>	2.0	102.0
<b>3604-2.5</b>	2.5	114.5
<b>3604-3</b>	3.0	129.0
<b>3604-4</b>	4.0	144.0
<b>3604-5</b>	5.0	165.0
<b>3604-6</b>	6.0	186.0
<b>3604-7</b>	7.0	197.0
<b>3604-8</b>	8.0	208.0
<b>3604-10</b>	10.0	234.0
<b>3606-12</b>	12.0	260.0
<b>3606-14</b>	14.0	294.0
<b>3606-17</b>	17.0	337.0
<b>N 3606-19</b>	19.0	379.0

**Offset ballpoint hexagon key wrench set**  
extra long, polished and mat chromed

**Juego de llaves hexagonales macho acodadas con bola**

extra largas, pulidas y cromadas satinado mate

**Jogo de chaves em "L" sextavada interior com ponta esférica**

extra longas, polidas e cromadas mate



DIN / ISO 2936



Art.	mm
<b>3604</b>	1.5-2-2.5-3-4-5-6-7-8-10

**Offset ballpoint hexagon key wrench case**  
extra long, mat chromed

**Estuche de llaves hexagonales macho acodadas con bola**

extra largas, cromadas satinado mate

**Mala de chaves em "L" sextavada interior com ponta esférica**

extra longas, cromadas mate



DIN / ISO 2936



360 x 185 x 52 mm

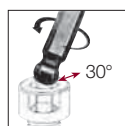

Art.	mm
<b>3606</b>	3-4-5-6-7-8-10-12-14-17

**Inch offset ballpoint hexagon key wrench**  
extra long, polished and mat chromed

**Llave hexagonal macho acodada con bola pulgada**

extra larga, pulida y cromada satinado mate

**Chave em "L" sextavada interior com ponta esférica polegada**

extra longa, polida e cromada mate



Art.	inch	L mm
<b>3603-1/16</b>	1/16"	92
<b>3603-5/64</b>	5/64"	100
<b>3603-3/32</b>	3/32"	114
<b>3603-1/8</b>	1/8"	130
<b>3603-5/32</b>	5/32"	142
<b>3603-3/16</b>	3/16"	165
<b>3603-1/4</b>	1/4"	185
<b>3603-5/16</b>	5/16"	208
<b>3603-3/8</b>	3/8"	235



**Inch offset ballpoint hexagon key wrench set**  
extra long, polished and mat chromed

**Juego de llaves hexagonales macho acodadas con bola pulgadas**

extra largas, pulidas y cromadas satinado mate

**Jogo de chaves em "L" sextavada interior com ponta esférica polegadas**

extra longas, polidas e cromadas mate



inch **S2**  
quality

**XXL** **9**  
PCS



Art.	inch
<b>3603</b>	1/16"-5/64"-3/32"-1/8"-5/32" 3/16"-1/4"-5/16"-3/8"

**Offset key wrench for TX screws**  
mat chromed

**Llave macho acodada para tornillos TX**

cromada satinado mate

**Chave em "L" TX**

cromada mate



Art.		mm	L mm
<b>3605-10</b>	T10	2.7	50
<b>3605-15</b>	T15	3.3	55
<b>3605-20</b>	T20	3.8	60
<b>3605-25</b>	T25	4.4	68
<b>3605-27</b>	T27	5.0	75
<b>3605-30</b>	T30	5.5	85
<b>3605-40</b>	T40	6.6	95
<b>3605-45</b>	T45	7.82	110
<b>3605-50</b>	T50	8.83	120



**Offset key wrench set for TX screws**  
mat chromed

**Juego de llaves macho acodadas para tornillos TX**

cromadas satinado mate

**Jogo de chaves em "L" TX**

cromadas mate



**9**  
PCS



Art.	
<b>3605</b>	T10-T15-T20-T25-T27 T30-T40-T45-T50

### Offset key wrench for TX screws



extra long, polished and mat chromed

### Llave macho acodada para tornillos TX

extra larga, pulida y cromada satinado mate

### Chave em "L" TX

extra longa, polida e cromada mate

Art.		 mm	L mm
<b>3607-10</b>	T10	2.7	93
<b>3607-15</b>	T15	3.3	104
<b>3607-20</b>	T20	3.8	116
<b>3607-25</b>	T25	4.4	131
<b>3607-27</b>	T27	5.0	145
<b>3607-30</b>	T30	5.5	166
<b>3607-40</b>	T40	6.6	187
<b>3607-45</b>	T45	7.82	209
<b>3607-50</b>	T50	8.83	235



S2  
quality

XXL



### Offset key wrench set for TX screws

extra long, polished and mat chromed

### Juego de llaves macho acodadas para tornillos TX

extra largas, pulidas y cromadas satinado mate

### Jogo de chaves em "L" TX

extra longas, polidas e cromadas mate



S2  
quality

XXL

9  
PCS



Art.	
<b>3607</b>	T10-T15-T20-T25-T27 T30-T40-T45-T50

**Offset ballpoint key wrench for TX screws**

long, polished and mat chromed



**Llave macho acodada con bola para tornillos TX**

larga, pulida y cromada satinado mate

**Chave em "L" TX com ponta esférica**

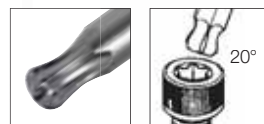
longa, polida e cromada mate



Art.			 mm	L mm
<b>3608-10</b>	T10		2.7	87
<b>3608-15</b>	T15		3.3	92
<b>3608-20</b>	T20		3.8	96
<b>3608-25</b>	T25		4.4	102
<b>3608-27</b>	T27		5.0	110
<b>3608-30</b>	T30		5.5	118
<b>3608-40</b>	T40		6.6	130
<b>3608-45</b>	T45		7.82	137
<b>3608-50</b>	T50		8.83	160

**Offset ballpoint key wrench set for TX screws**

long, polished and mat chromed



**Juego de llaves macho acodadas con bola para tornillos TX**

largas, pulidas y cromadas satinado mate

**Jogo de chaves em "L" TX com ponta esférica**

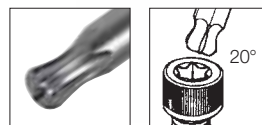
longas, polidas e cromadas mate



Art.		
<b>3608</b>	T10-T15-T20-T25-T27 T30-T40-T45-T50	

### Offset key wrench for TX screws

with bore hole at the tip, for normal TX screws and tamperproof TX screws



**extra long**, polished and mat chromed

### Llave macho acodada para tornillos TX

con punta perforada, para tornillos TX con y sin punta de seguridad **extra larga**, pulida y cromada satinado mate

### Chave em "L" TX

com furo na ponta, para parafusos com e sem ponta de segurança **extra longa**, polida e cromada mate

Art.		 mm	L mm
<b>3609-10</b>	T10	2.7	93
<b>3609-15</b>	T15	3.3	104
<b>3609-20</b>	T20	3.8	116
<b>3609-25</b>	T25	4.4	131
<b>3609-27</b>	T27	5.0	145
<b>3609-30</b>	T30	5.5	166
<b>3609-40</b>	T40	6.6	187
<b>3609-45</b>	T45	7.82	209
<b>3609-50</b>	T50	8.83	235



S2  
quality

XXL



### Offset key wrench set for TX screws

with bore hole at the tip, for normal TX screws and tamperproof TX screws

**extra long**, polished and mat chromed

### Juego de llaves macho acodadas para tornillos TX

con punta perforada, para tornillos TX con y sin punta de seguridad **extra largas**, pulidas y cromadas satinado mate

### Jogo de chaves em "L" TX

com furo na ponta, para parafusos com e sem ponta de segurança **extra longas**, polidas e cromadas mate

Art.	
<b>3609</b>	T10-T15-T20-T25-T27 T30-T40-T45-T50



S2  
quality

XXL

9  
PCS



### Offset key wrench set for TX screws

with bore hole at the tip, for normal TX screws and tamperproof TX screws

**extra short**, polished and mat chromed

### Juego de llaves macho acodadas para tornillos TX

con punta perforada, para tornillos TX con y sin punta de seguridad **extra cortas**, pulidas y cromadas satinado mate

### Jogo de chaves em "L" TX

com furo na ponta, para parafusos com e sem ponta de segurança **extra curtas**, polidas e cromadas mate

Art.	
<b>3609S</b>	T10-T15-T20-T25-T27-T30-T40



S2  
quality

7  
PCS





### Offset key wrench set for TX screws

with bore hole at the tip, for normal TX screws and tamperproof TX screws

long, made of stainless steel

**Juego de llaves macho acodadas para tornillos TX**  
con punta perforada, para tornillos TX con y sin punta de seguridad largas, en acero inoxidable

### Jogo de chaves em "L" TX

com furo na ponta, para parafusos com e sem ponta de segurança longas, em aço inoxidável



inox 9  
PCS

NEW  
NUEVO  
NOVO



Art.	☆
<b>3645</b>	T10-T15-T20-T25-T27-T30-T40-T45-T50

### Hexagon T-handle wrench

2 hexagon male ends and 1 ballpoint hexagon male end

### Llave en T hexagonal

con 2 extremidades macho hexagonales y 1 extremidad con bola

### Chave sextavada interior cabo em "T"

2 pontas macho hexagonal, 1 ponta esférica



Art.	⬡ ⬢ mm	L 1 mm	L 2 mm
<b>2593-02</b>	2.0	65	126
<b>2593-025</b>	2.5	65	126
<b>2593-03</b>	3.0	65	126
<b>2593-04</b>	4.0	90	180
<b>2593-05</b>	5.0	90	180
<b>2593-06</b>	6.0	105	210
<b>2593-07</b>	7.0	105	210
<b>2593-08</b>	8.0	125	250
<b>2593-10</b>	10.0	145	300

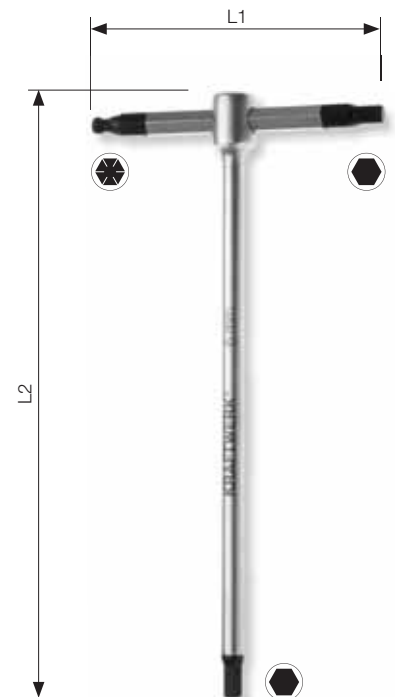

Double joint hexagonal key set  
*Juego de llaves macho doble articuladas*  
 Jogo de chaves sextavados interior dupla  
 articulação



CrV 6 PCS

NEW  
NUEVO  
NOVO



Art.	
<b>3025</b>	3-4-5-6-8-10 mm



Video  
[KRAFTWERKtools.com/video/3625-27](https://www.kraftwerktools.com/video/3625-27)

Double joint TX key set  
*Juego de llaves TX doble articuladas*  
 Jogo de chaves TX dupla articulação



CrV 7 PCS

NEW  
NUEVO  
NOVO



Art.	
<b>3026</b>	T20-T25-T27-T30-T40-T45-T50



Video  
[KRAFTWERKtools.com/video/3625-27](https://www.kraftwerktools.com/video/3625-27)

Double joint XZN spline key set  
*Juego de llaves XZN doble articuladas*  
 Jogo de chaves XZN dupla articulação



CrV 5 PCS

NEW  
NUEVO  
NOVO



Art.	
<b>3027</b>	M4-M5-M6-M8-M10



Video  
[KRAFTWERKtools.com/video/3625-27](https://www.kraftwerktools.com/video/3625-27)

### Hexagon T-handle wrench case

2 hexagon male ends and 1 ballpoint hexagon male end

### Estuche de llaves en T hexagonal

con 2 extremidades macho hexagonales y 1 extremidad con bola

### Mala de chaves sextavada interior cabo em "T"

2 pontas macho hexagonal, 1 ponta esférica



9  
PCS

**COMPLETO**



Art. 2593-02	2.0 mm
Art. 2593-025	2.5 mm
Art. 2593-03	3.0 mm
Art. 2593-04	4.0 mm
Art. 2593-05	5.0 mm
Art. 2593-06	6.0 mm
Art. 2593-07	7.0 mm
Art. 2593-08	8.0 mm
Art. 2593-10	10.0 mm

Art.

**4900-35K**



421 x 200 x 68 mm

### T-handle wrench for TX screws

2 TX male ends and 1 tamper TX male end

### Llave en T para tornillos TX

con 2 extremidades macho TX y 1 extremidad TX de seguridad

### Chave TX cabo em "T"

2 pontas macho TX, 1 ponta TX com furo



Art.	mm	mm	L 1 mm	L 2 mm
<b>2594-10</b>	T10	2.7	65	125
<b>2594-15</b>	T15	3.2	65	125
<b>2594-20</b>	T20	3.8	65	125
<b>2594-25</b>	T25	4.4	90	180
<b>2594-27</b>	T27	4.9	90	180
<b>2594-30</b>	T30	5.5	90	180
<b>2594-40</b>	T40	6.6	105	210
<b>2594-45</b>	T45	7.82	105	210
<b>2594-50</b>	T50	8.83	105	215

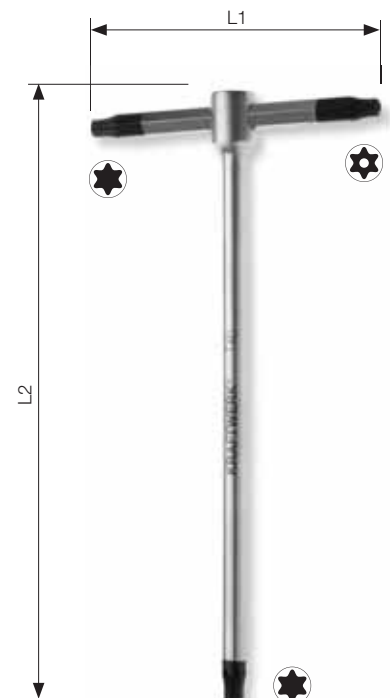



### T-handle wrench case for TX screws

2 TX male ends and 1 tamper TX male end

### Estuche de llaves en T para tornillos TX

con 2 extremidades macho TX y 1 extremidad TX de seguridad

### Mala de chaves TX cabo em "T"

2 pontas macho TX, 1 ponta TX com furo

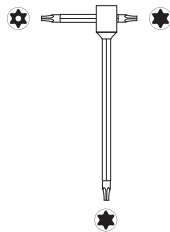

Art. 2594-10	T10
Art. 2594-15	T15
Art. 2594-20	T20
Art. 2594-25	T25
Art. 2594-27	T27
Art. 2594-30	T30
Art. 2594-40	T40
Art. 2594-45	T45
Art. 2594-50	T50

Art.

**4900-36K**



9  
PCS

**COMPLETO**



421 x 200 x 68 mm

### Foldable hexagon key wrench set

with ergonomic holder

### Juego llaves hexagonal macho

en navaja ergonómica

### Jogo desdobrável chaves sextavada

interior em suporte ergonómico



8  
PCS



115 x 40 x 40 mm

Art.

**3623**

1.5-2-2.5-3-4-5-6-8

### Foldable TX key wrench set

with ergonomic holder

### Juego llaves macho para tornillos TX

en navaja ergonómica

### Jogo desdobrável chaves TX

em suporte ergonómico



8  
PCS



115 x 40 x 40 mm

Art.

**3624**

T9-T10-T15-T20-T25-T27-T30-T40